

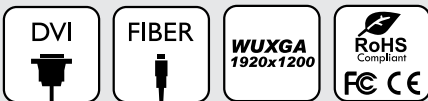

AV Connectivity, Distribution And Beyond...

**VIDEO WALLS VIDEO PROCESSORS
VIDEO MATRIX SWITCHES
EXTENDERS SPLITTERS WIRELESS
CABLES & ACCESSORIES**

DVI Extender over Single Fiber Optic Cable with Self-Detecting EDID and EMI Shielding



Model #: FO-DVI-1000M-EMIX

© 2013 Avenview Inc. All rights reserved.

The contents of this document are provided in connection with Avenview Inc. ("Avenview") products. Avenview makes no representations or warranties with respect to the accuracy or completeness of the contents of this publication and reserves the right to make changes to specifications and product descriptions at any time without notice. No license, whether express, implied, or otherwise, to any intellectual property rights is granted by this publication. Except as set forth in Avenview Standard Terms and Conditions of Sale, Avenview assumes no liability whatsoever, and claims any express or implied warranty, relating to its products are strictly prohibited.

Product Application & Market Sectors



Corporate



House Of Worship



Military



Residential



Education



Industrial



Medical



Aviation



TABLE OF CONTENTS

1.	GETTING STARTED	1
1.1	IMPORTANT SAFEGUARDS.....	1
1.2	SAFETY INSTRUCTIONS	1
1.3	REGULATORY NOTICES FEDERAL COMMUNICATIONS COMMISSION (FCC)	2
2.	INTRODUCTION	3
2.1	PACKAGE CONTENTS	3
2.2	BEFORE INSTALLATION.....	4
3.	INSTALLATION.....	4
4.	TROUBLESHOOTING.....	4
5.	CAUTION.....	5
6.	SPECIFICATIONS	5
6.1	CASE DIMENSIONS.....	6
6.2	ABSOLUTE MAXIMUM RATINGS.....	7
6.3	ELECTRICAL SPECIFICATIONS	7
6.3.1	Transmitter Module.....	7
6.3.2	Receiver Module	8
6.4	SIGNAL PIN ASSIGNMENT	8
6.4.1	Transmitter/Receiver	8
6.5	OPTICAL FIBER CABLE	9



SECTION I: GETTING STARTED

I.1 IMPORTANT SAFEGUARDS

Please read all of these instructions carefully before you use the Fiber Optic cable. Save this manual for future reference.

What the warranty does not cover

- Any product, on which the serial number has been defaced, modified or removed.
- Damage, deterioration or malfunction resulting from:
- Accident, misuse, neglect, fire, water, lightning, or other acts of nature, unauthorized product modification, or failure to follow instructions supplied with the product.
- Repair or attempted repair by anyone not authorized by us.
- Any damage of the product due to shipment.
- Removal or installation of the product.
- Causes external to the product, such as electric power fluctuation or failure.
- Use of supplies or parts not meeting our specifications.
- Normal wear and tear.
- Any other causes which does not relate to a product defect.
- Removal, installation, and set-up service charges.

I.2 SAFETY INSTRUCTIONS

The Avenview FO-DVI-1000M-EMIX, DVI Extender over Fiber Optic has been tested for conformity to safety regulations and requirements, and has been certified for international use. However, like all electronic equipment's, the FO-DVI-1000M-EMIX should be used with care. Read the following safety instructions to protect yourself from possible injury and to minimize the risk of damage to the unit.

On no account should you:





- ⚠ Look into a fiber while the system lasers are on;
- ⚠ Use unfiltered handheld magnifiers or focusing optics to inspect fiber connectors;
- ⚠ Connect a fiber to a fiberscope while the system lasers are on;
- ⚠ Touch the end of the fiber connectors;
- ⚠ Pull forcefully on the fiber cable;
- ⚠ Reuse any specified fiber cleaning material more than once;
- ⚠ Touch the clean area of a any specified fiber cleaning material;
- ⚠ Use alcohol around an open flame or spark - Alcohol is Very Flammable;
- ⚠ Use alcohol or wet cleaning without a way to ensure that it does not leave residue on the polished connector;
- ⚠ Dismantle the housing or modify the connector.
- ⚠ Do not use liquid or aerosol cleaners to clean this unit. Always unplug the power to the device before cleaning.



1.3 REGULATORY NOTICES FEDERAL COMMUNICATIONS COMMISSION (FCC)

This equipment has been tested and found to comply with Part 15 of the FCC rules. These limits are designed to provide reasonable protection against harmful interference in a residential installation.

Any changes or modifications made to this equipment may void the user's authority to operate this equipment.

Warning symbols	Description
	<p style="text-align: center;">LASER RADIATION DO NOT STARE INTO BEAM < 1 MILLIWATT LASER DIODE CLASS 2 LASER PRODUCT</p> <p>Risk levels increase. These lasers emit a visible beam, from 400 to 780 Nanometres (nm), with an upper power limit of 1 milliwatt. An example is a (mw) bar code scanner. Momentary viewing is not hazardous, but extended viewing is. Laser protective eyewear is recommended for even momentary viewing and necessary for extended viewing</p>
	<p style="text-align: center;">DO NOT TAMPER WITH THE FIBER CABLE; DOING SO WILL VOID THE WARRANTY AND CONTINUED USE OF THE PRODUCT.</p>
	<p style="text-align: center;">LASER BEAM USED IN OPTICAL COMMUNICATIONS ARE INVISIBLE AND CAN SERIOUSLY DAMAGE THE EYES. VIEWING IT DIRECTLY DOES NOT CAUSE ANY PAIN TO THE EYE BUT SERIOUS DAMAGE CAN BE DONE TO THE RETINA OF THE EYE</p>
	<div style="border: 1px solid black; padding: 5px;"> <p style="background-color: orange; color: black; padding: 2px;">⚠ WARNING</p> <p>Read & understand user guide before using this device.</p> <p>Failure to follow the proper installation instructions could result in damage to the product and preventing expected results.</p> </div>

2. INTRODUCTION

Avenview FO-DVI-1000M-EMIX DVI Extender over Fiber lets you extend digital flat panel signal up to 1080p (1920x1080) and WUXGA at 1920 x 1200 and 1000 meters (3300 feet) away from the host by TMDS digital signal and EDID transmission with only 1 SC fiber.

- High Speed and long distance transmission by SC type Multi-Mode 1 fiber
- R, G, B, Clock signal is transmitted by 1 Multi-Mode optical Fiber
- EDID data is transmitted by 1 Multi-Mode optical Fiber
- Supports 12bit deep color
- Standard DVI plug and SC Fiber connector
- Supports resolution up to HDTV / 1080P, PC / WUXGA (1920 x 1200)
- HDCP compliant
- Optional external power supply

2.1 PACKAGE CONTENTS

Before you start the installation of the converter, please check the package contents.

1	Transmitter	X 1	
2	Receiver	X 1	
3	Power Adapter (5VDC, 2A Optional)	X 1	
4	User's Manual	X 1	



2.2 BEFORE INSTALLATION

- Put the product in an even and stable location. If the product falls down or drops, it may cause an injury or malfunction.
- Don't place the product in too high temperature (over 50°C), too low temperature (under 0°C) or high humidity.
- Use the DC power adapter with correct specifications. If inappropriate power supply is used then it may cause a fire.
- Do not twist or pull by force ends of the optical cable. It can cause malfunction.

3. INSTALLATION

This product is composed of a Transmitter and a Receiver. The Transmitter should be connected to the computer's DVI Port and the Receiver should be connected the DVI Port of the digital display device. Avenview FO-DVI-1000M-EMIX Transmitter/ Receiver is designed to be used with SC type standard optical cable (Multi-Mode optical fiber: 50/125, 62.5/125um).

Avenview FO-DVI-1000M-EMIX is designed to self-detect the resolution of the monitor and change the resolution accordingly. Follow these steps for connecting to a device:

1. Power on your Display
2. Connect Transmitter to the DVI Source and Receiver to the Display.
3. Connect the optical fiber between Transmitter and Receiver.
4. Connect DC power to the Receiver
5. Restart the computer.

4. TROUBLESHOOTING

Problem	Possible Solutions
NO IMAGE	<ul style="list-style-type: none">• Check if the PC Power is on• Check if connection to the computer and the monitor are correct.• Turn the PC Power off and on again.
SCREEN DEFECTS APPEAR	<ul style="list-style-type: none">• This product supports up to WUXGA resolution.• Check the maximum resolution range of the graphics card.



5. CAUTION

1. Do not put heavy object on top of the FO-DVI-1000M-EMIX. It may cause product malfunction.
2. Put the product on even and stable location. If the product falls down or dropped, it may get damaged.
3. Keep away from high temperature (over 50°C), low temperature (under 0°C) or high humidity. It may cause a fire and injury by electrical shock.
4. Use DC power adapter with correct specification. Otherwise it may cause fire.
5. Do not twist or pull by force either ends of the optical cable. It can cause malfunction. Minimum bending diameter is 75mm.
6. Use the multimode (50/125um, 62.5/125um) optical fiber.

6. SPECIFICATIONS

ITEM	DESCRIPTION	
UNITS	FO-DVI-1000M-EMIX (Transmitter)	FO-DVI-1000M-EMIX (Receiver)
UNIT DESCRIPTION	DVI Transmitter over Fiber Optic	DVI Receiver over Fiber
DVI COMPLIANCE	DVI 1.0	
HDCP COMPLIANCE	HDCP 1.1	
VIDEO BANDWIDTH	2.25 Gbps Single Link	
SUPPORTED RESOLUTION & DISTANCE	Video 1080p (1920 x 1080) @ 1000 meters (3300 feet) PC WUXGA (1920 x 1200) @ 1000 meters (3300 feet)	
OPTICAL CONVERTER	4 Ch 850 nm Transmit OSA 911nm, 1 Ch VCSEL 980nm, 1 Ch PIN P/D Diode	4 Ch 850 nm Transmit OSA 911nm, 1 Ch VCSEL 980nm, 1 Ch PIN P/D Diode
DVI CONNECTOR	24 pin DVI-D Plug	
OPTICAL CONNECTOR	1 SC Connector	
FIBER TYPE	50/125 μm Multi-mode glass fiber	
POWER CONSUMPTION	1.0W (max)	0.75W (max)
POWER SUPPLY(OPTIONAL)	100 ~ 240V 5V 2A DC	
DIMENSIONS (L X W X H)	2.4" x 1.5" x 0.6"	
ENVIRONMENTAL		
OPERATING TEMPERATURE	32° ~ 104°F (0° to 40°C)	
STORAGE TEMPERATURE	-4° ~ 140°F (-20° ~ 60°C)	
RELATIVE HUMIDITY	20~90% RH (no condensation)	



6.1 CASE DIMENSIONS

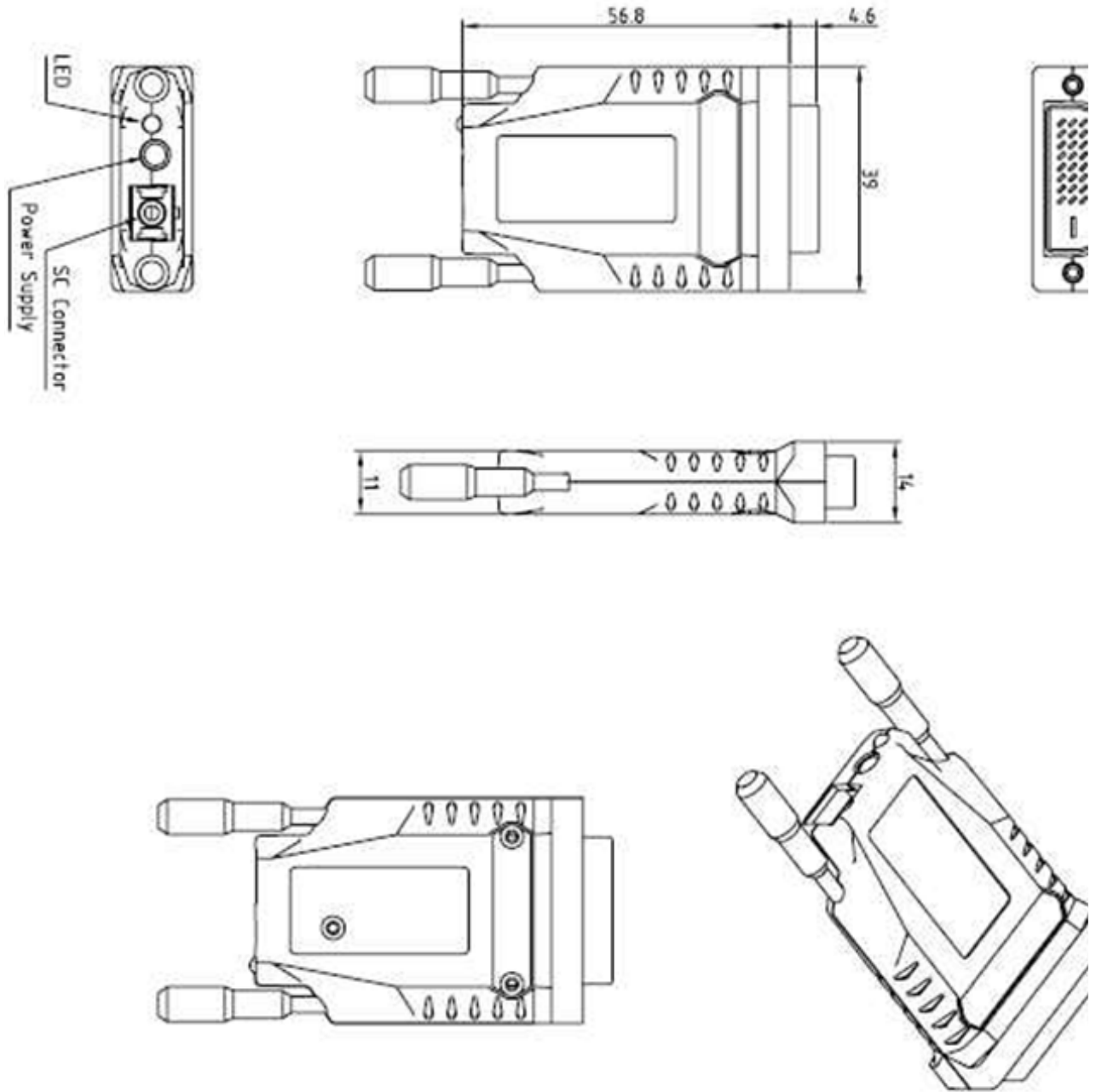

6.2 ABSOLUTE MAXIMUM RATINGS

PARAMETER	SYMBOL	MINIMUM	MAXIMUM	UNITS
POWER SUPPLY	VCC	-0.3	+5.5	V
OPERATING TEMPERATURE	VOT	0	+50	°C
STORAGE TEMPERATURE	VST	-20	+70	°C
RELATIVE HUMIDITY	HRH	10	80	RH

Stresses greater than those listed under “Absolute Maximum Ratings” may cause permanent damage to the device. This is a stress rating only and functional operation of the device at these or any other conditions above those indicated in the operations section for extended periods of time may affect reliability.

6.3 ELECTRICAL SPECIFICATIONS

6.3.1 Transmitter Module

	PARAMETER	SYMBOL	MIN	TYPE	MAX	UNITS
POWER	Supply Voltage (Optional External Power)	V _{cc}	4.5	5	5.5	V
	Supply Current	I _{cc}	-	220	225	mA
	Power Dissipation	P _o	-	1.1	1.24	W
TMDS	Reference Voltage for Graphic Signal	V _{REF}	3.1	3.3	3.5	V
	Signal ended High Level Input Voltage	V _H	V _{REF} -0.01		V _{REF} +0.01	V
	Signal ended Low Level Input Voltage	V _L	V _{REF} -0.6		V _{REF} -0.4	V
	Signal ended Input Swing Voltage	V _{ISWING}	0.4		0.6	V
	Signal ended Standby Input Voltage		V _{REF} -0.01		V _{REF} +0.01	V
	Data Output Load	RLD		50		Ω

Transmitter module of Model DSP includes 4 channel VCSEL (Vertical Surface Emitting Laser Diode) with 850nm, 911 nm invisible laser radiation.



6.3.2 Receiver Module

	PARAMETER	SYMBOL	MIN	TYPE	MAX	UNITS
POWER	Supply Voltage (External Power)	V _{CC}	4.5	5	5.5	V
	Supply Current	I _{CC}	-	150	155	mA
	Power Dissipation	P _o	-	0.75	0.853	W
TMDS	Reference Voltage for Graphic Signal	V _{REF}	3.1	3.3	3.5	V
	Signal ended Input Swing Voltage	V _{OSWING}	0.4		0.6	V
	Data Input Load	RLD		50		Ω

6.4 SIGNAL PIN ASSIGNMENT

6.4.1 Transmitter/Receiver

PIN	SIGNAL ASSIGNMENT	PIN	SIGNAL ASSIGNMENT	PIN	SIGNAL ASSIGNMENT
1	T.M.D.S. Data2-	9	T.M.D.S. Data1-	17	T.M.D.S. Data0-
2	T.M.D.S. Data2+	10	T.M.D.S. Data1+	18	T.M.D.S. Data0+
3	T.M.D.S. Data2 Shield	11	T.M.D.S. Data1 Shield	19	T.M.D.S. Data0 Shield
4	No Connect	12	No Connect	20	No Connect
5	No Connect	13	No Connect	21	No Connect
6	DDC Clock (SCL)	14	+5V Power	22	T.M.D.S. Clock Shield
7	DDC Data (SDA)	15	Ground (for +5V)	23	T.M.D.S. Clock+
8	No Connect	16	Hot Plug Detect	24	T.M.D.S. Clock-



6.5 OPTICAL FIBER CABLE

The construction of 4 Optical Fibers and 4 Copper wires cable shall be in accordance with Figure and Table below:

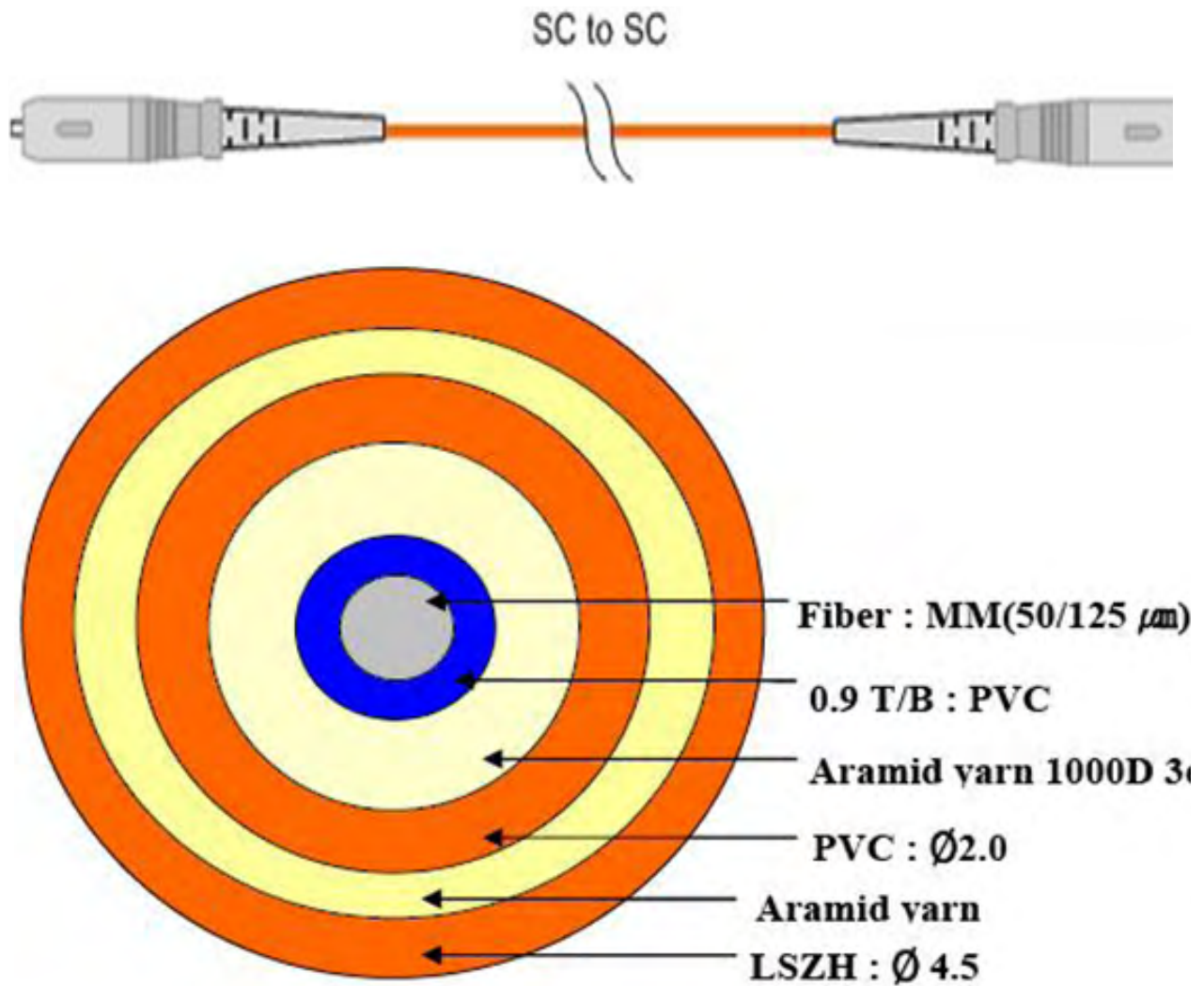

Avenview Warranty Certificate

AVENVIEW CORP. ("Avenview") warrants Avenview-branded product(s) contained in the original packaging against defects in materials and workmanship when used normally in accordance with Avenview's enclosed manual guidelines for a period of THREE (3) YEARS from the date of original retail purchase - Warranty Period. Avenview's published guidelines include but are not limited to information contained in technical specifications, user manuals and service communications.

LABOR: During the Warranty Period of THREE (3) YEARS, Avenview will repair or replace the product(s) at no cost using new or used parts equivalent to novel performance and reliability if the product(s) is determined to have abide by Avenview's published guidelines. Cost of Labor applicable to product(s) after Warranty Period. For labor costs, please contact support@avenview.com.

PARTS: During the Warranty Period of THREE (3) YEARS, Avenview will supply new or rebuilt replacements in exchange for defective parts of the product(s) at no cost if the product(s) is determined to have abide by Avenview's published guidelines. Cost of Parts applicable to product(s) after Warranty Period. For part(s) costs, please contact support@avenview.com.

To obtain Warranty: (a) proof of purchase in the form of a bill of sale or receipted invoice reflecting that the registered product(s) is within warranty period must be presented to obtain warranty service; (b) product(s) must be registered at time of purchase. Failure to do so will result in applicable parts and labor charges. Returning product(s) must be shipped in Avenview's original packaging or in packaging pertaining equal degree of protection to Avenview's. Both Avenview and purchaser are responsible for freight charges and brokerages when shipping the product(s) to the receiver.

NOT COVERED BY THIS WARRANTY

This warranty does not apply to any non-Avenview branded product(s); non-registered Avenview product(s). This warranty does not apply: (a) to cosmetic damage, including but not limited to scratches, dents and broken cords; (b) to damage caused by use with another product; (c) to damage caused by accident, abuse, misuse, liquid contact, fire, earthquake or other external cause; (d) to damage caused by operating the Avenview product(s) outside Avenview's manuals or guidelines; (e) to damage caused by service performed by anyone who is not a representative of Avenview or an Avenview authorized personnel; (f) to defects caused by normal wear and tear or otherwise due to the normal aging of the Avenview product(s), or (g) if any serial number has been removed or defaced from the Avenview product(s).

AVENVIEW IS NOT LIABLE FOR DIRECT, SPECIAL, INCIDENTAL OR CONSEQUENTIAL DAMAGES RESULTING FROM ANY BREACH OF WARRANTY OR CONDITION, OR UNDER ANY OTHER LEGAL THEORY, INCLUDING BUT NOT LIMITED TO LOSS OF USE; LOSS OF REVENUE; LOSS OF ACTUAL OR ANTICIPATED PROFITS (INCLUDING LOSS OF PROFITS ON CONTRACTS); LOSS OF THE USE OF MONEY; LOSS OF ANTICIPATED SAVINGS; LOSS OF BUSINESS; LOSS OF OPPORTUNITY; LOSS OF GOODWILL; LOSS OF REPUTATION; LOSS OF, DAMAGE TO, COMPROMISE OR CORRUPTION OF DATA; OR ANY INDIRECT OR CONSEQUENTIAL LOSS OR DAMAGE REPAIR OR REPLACEMENT AS PROVIDED UNDER THIS WARRANTY IS THE EXCLUSIVE REMEDY OF THE CONSUMER.

Some states do not allow the inclusion or limitation of incidental or consequential damages, or allow limitations on duration implements of the Warranty Period; therefore the above limitations or exclusions may not be applicable to you. This warranty gives you specific legal rights, and you may have other rights which vary from state to state.



275 Woodward Avenue, Kenmore, NY 14217
1.866.508.0269





AV Connectivity, Distribution And Beyond...

TECHNICAL SUPPORT

CONTACT US



Phone: 1 (866) 508 0269



Email: support@avenview.com



USA Head Office Avenview Corp. 275 Woodward Avenue Kenmore, NY 14217

USA Head Office

Office Avenview
Corp. 275 Woodward Avenue
Kenmore, NY 14217
Phone: +1.716.218.4100 ext223
Fax: +1.866.387-8764
Email: info@avenview.com

Canada Sales

Avenview
151 Esna Park Drive, Unit 11 & 12
Markham, Ontario, L3R 3B1
Phone: 1.905.907.0525
Fax: 1.866.387.8764
Email: info@avenview.com

Avenview Europe

Avenview Europe
Demkaweg 11
3555 HW Utrecht
Netherlands
Phone: +31 (0)85 2100- 613
Email: info@avenview.eu

Avenview Hong Kong

Unit 8, 6/F, Kwai Cheong Centre,
50 Kwai Cheong Road,
Kwai Chung, N.T.
Hong Kong
Phone: 852-3575 9585
Email: wenxi@avenview.com

Disclaimer

While every precaution has been taken in the preparation of this document, Avenview Inc. assumes no liability with respect to the operation or use of Avenview hardware, software or other products and documentation described herein, for any act or omission of Avenview concerning such products or this documentation, for any interruption of service, loss or interruption of business, loss of anticipatory profits, or for punitive, incidental or consequential damages in connection with the furnishing, performance, or use of the Avenview hardware, software, or other products and documentation provided herein.

Avenview Inc. reserves the right to make changes without further notice to a product or system described herein to improve reliability, function or design. With respect to Avenview products which this document relates, Avenview disclaims all express or implied warranties regarding such products, including but not limited to, the implied warranties of merchantability, fitness for a particular purpose, and non-infringement.