



Control Your Video

VIDEO WALL VIDEO PROCESSORS
MULTIVIEWERS DIGITAL SIGNAGE
EXTENDERS CONTROL CENTERS
SCALERS WIRELESS

HDBaseT VGA and Composite Scaler Over CAT5e/6/7 Transmitter with LAN Support



Model #: HBT-C6POE-VGA-S

© 2015 Avenview Inc. All rights reserved.

The contents of this document are provided in connection with Avenview Inc. ("Avenview") products. Avenview makes no representations or warranties with respect to the accuracy or completeness of the contents of this publication and reserves the right to make changes to specifications and product descriptions at any time without notice. No license, whether express, implied, or otherwise, to any intellectual property rights is granted by this publication. Except as set forth in Avenview Standard Terms and Conditions of Sale, Avenview assumes no liability whatsoever, and claims any express or implied warranty, relating to its products are strictly prohibited.

Product Application & Market Sectors



Corporate



House Of Worship



Military



Residential



Education



Industrial



Medical



Aviation



TABLE OF CONTENTS

1. GETTING STARTED	1
1.1 IMPORTANT SAFEGUARDS.....	1
1.2 SAFETY INSTRUCTIONS	1
1.3 REGULATORY NOTICES FEDERAL COMMUNICATIONS COMMISSION (FCC)	2
2. INTRODUCTION	3
3. FEATURES	3
4. PACKAGE CONTENTS	4
5. BEFORE INSTALLATION	4
6. APPLICATION DIAGRAM.....	5
7. PANEL DESCRIPTION	6
7.1 INPUT PANEL (FRONT PANEL)	6
7.2 INPUT PANEL (REAR PANEL)	7
7.3 REMOTE CONTROL	8
8. RS-232 PIN DEFINITIONS.....	9
9. RS-232 COMMANDS.....	10
10. OSD MENU	12
11. INPUT RESOLUTION SUPPORT.....	14
12. INSTALLATION	15
13. GENERAL TROUBLESHOOTING	15
14. SPECIFICATIONS	16



SECTION I: GETTING STARTED

I.1 IMPORTANT SAFEGUARDS

Please read all of these instructions carefully before you use the device. Save this manual for future reference.

What the warranty does not cover

- Any product, on which the serial number has been defaced, modified or removed.
- Damage, deterioration or malfunction resulting from:
- Accident, misuse, neglect, fire, water, lightning, or other acts of nature, unauthorized product modification, or failure to follow instructions supplied with the product.
- Repair or attempted repair by anyone not authorized by us.
- Any damage of the product due to shipment.
- Removal or installation of the product.
- External causes to the product, such as electric power fluctuation or failure.
- Use of supplies or parts not meeting our specifications.
- Normal wear and tear.
- Any other causes which does not relate to a product defect.
- Removal, installation, and set-up service charges.

I.2 SAFETY INSTRUCTIONS

The HBT-C6POE-VGA-S has been tested for conformance to safety regulations and requirements, and has been certified for international use. However, like all electronic equipments, the HBT-C6POE-VGA-S should be used with care. Read the following safety instructions to protect yourself from possible injury and to minimize the risk of damage to the unit.



- ⚠ Do not dismantle the housing or modify the module.
- ⚠ Dismantling the housing or modifying the module may result in electrical shock or burn.
- ⚠ Refer all servicing to qualified service personnel.
- ⚠ Do not attempt to service this product yourself as opening or removing housing may expose you to dangerous voltage or other hazards
- ⚠ Keep the module away from liquids.
- ⚠ Spillage into the housing may result in fire, electrical shock, or equipment damage. If an object or liquid falls or spills on to the housing, unplug the module immediately.
- ⚠ Have the module checked by a qualified service engineer before using it again.
- ⚠ Do not use liquid or aerosol cleaners to clean this unit. Always unplug the power to the device before cleaning.



1.3 REGULATORY NOTICES FEDERAL COMMUNICATIONS COMMISSION (FCC)

This equipment has been tested and found to comply with Part 15 of the FCC rules. These limits are designed to provide reasonable protection against harmful interference in a residential installation.

Any changes or modifications made to this equipment may void the user's authority to operate this equipment.

Warning symbols	Description
	<p>ONLY USE THE PROVIDED POWER CABLE OR POWER ADAPTER SUPPLIED. DO NOT TAMPER WITH THE ELECTRICAL PARTS. THIS MAY RESULT IN ELECTRICAL SHOCK OR BURN.</p>
	<p>DO NOT TAMPER WITH THE UNIT. DOING SO WILL VOID THE WARRANTY AND CONTINUED USE OF THE PRODUCT.</p>
	<p>THE VIDEO BOARDS ARE VERY SENSITIVE TO STATIC. PLEASE ENSURE IF RACK MOUNTED OR INSTALLED ON A SURFACE, IT SHOULD BE IN A GROUNDED ENVIROMENT.</p>

	<p>⚠ WARNING</p>
	<p>Read & understand user guide before using this device.</p> <p>Failure to follow the proper installation instructions could result in damage to the product and preventing expected results.</p>

2. INTRODUCTION

The HBT-C6POE-VGA-S is an HDBaseT™ Transmitter Scaler that supports PC (VGA) or Composite Video (CV) input. It is capable of scaling and switching video sources and sending the digital signal over CAT5e/6/7 cable to the Receiver at a distance of up to 100 meters, along with an external audio input, 2-way IR, RS-232 and bidirectional LAN support. Control is via on-panel buttons or IR remote control and there is an On-screen Display (OSD) providing selection and system information. The HBT-C6POE-VGA-S provides a full range of output resolutions, from 640 up to 1080p and WUXGA (RB). The bidirectional Power over Ethernet (PoE) function provides greater flexibility during installations.

3. FEATURES

- Supports PC/CV scaling to a full range of HDTV or PC resolutions up to 1080p and WUXGA (RB).
- Transmission of uncompressed data over a single CAT5e/6/7 cable up to 100m/328ft.
- 5Play™ convergence: Video and Audio, LAN serving, bidirectional Power over Ethernet (PoE) and Control (IR RS-232 bypass).
- Supports IR, Remote control, RS-232 (bypass) and on-panel controls.
- Provides bidirectional 24V DC power to or receive from compatible PoE Receiver through CAT5e/6/7 cable.
- Supports Ethernet transmission rates up to 100 Mbps.
- Supports NTSC and PAL formats for Composite Video input.



Note:

1. *This system was tested with CAT6/23AWG cables, results may vary with cables of different specifications.*
2. *The PoE function is designed for powering compatible Receiver units only—non-PoE Receivers will need their own power supply. Receivers from other brands may not be compatible.*
3. *DO NOT connect the LAN connection to the CAT5e/6/7 port. Doing so may cause a power shutdown and may damage the device.*



4. PACKAGE CONTENTS

Before you start the installation of the converter, please check the package contents.

1	HBT-C6POE-VGA-S	X 1	
2	POWER ADAPTER 24V2.7A	X 1	
3	USER'S MANUAL	X 1	

5. BEFORE INSTALLATION

- Put the product in a level and stable location. If the product falls, it may cause damage or malfunction to components within the casing.
- Do not place the product in temperatures under 0°C or over 50°C. High humidity may also cause the unit to malfunction.
- Use the DC power adapter with correct specifications supplied with the unit. If the improper power supply is used, this may result in malfunction of the unit and may cause fire.
- Do not twist or pull by force the ends of the HDMI cable. It can cause malfunction.



6. APPLICATION DIAGRAM

HBT-C6POE-VGA-S

CABLE INDEX

- Input / Output
- CAT-5e / CAT-6
- CAT 6 INTERNET
- RS-232-CONTROL

Application Diagram 1 POINT TO POINT

1080p60 = 100m (328 feet) CAT6
WUXGA = 100m (328 feet) CAT6

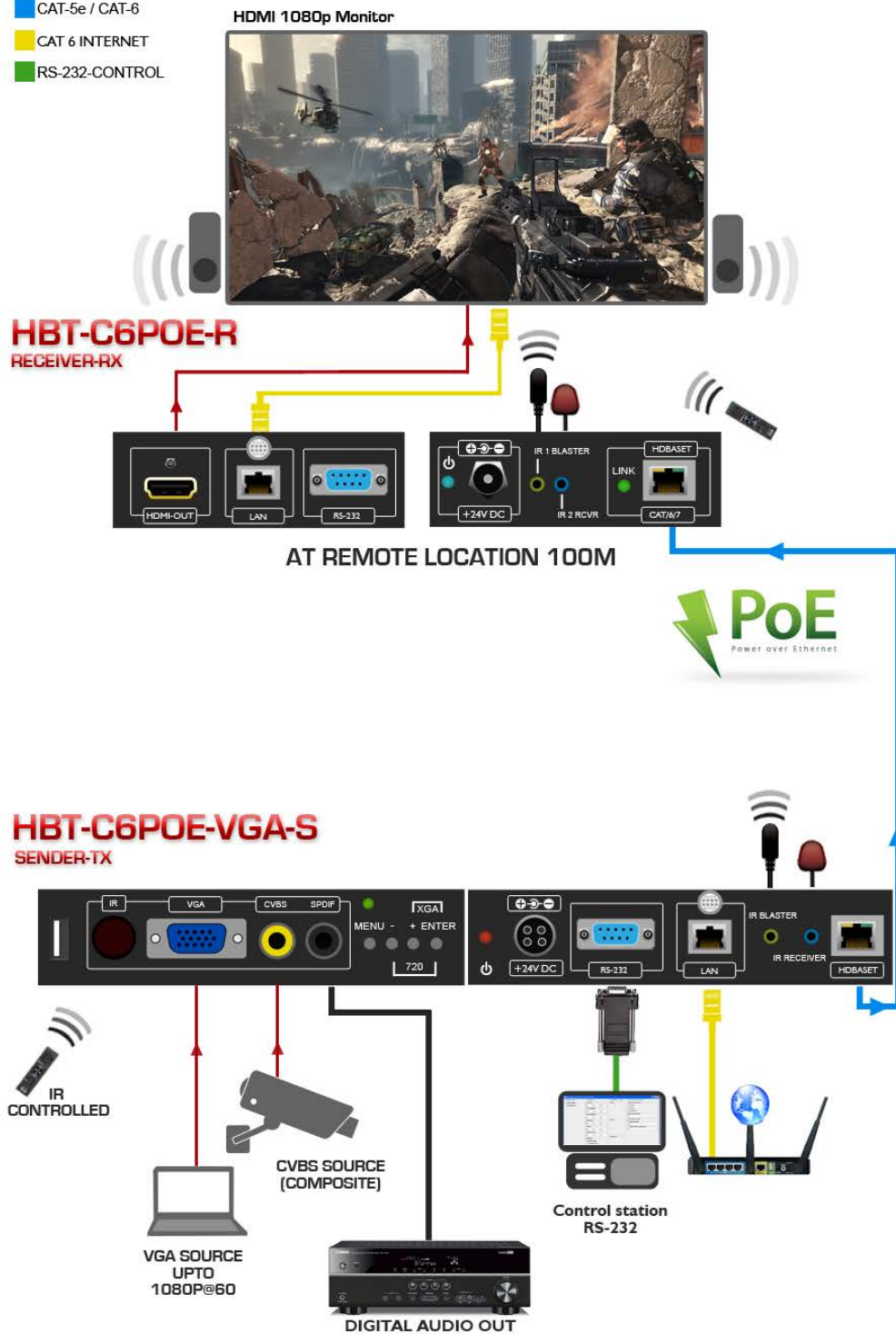

7. PANEL DESCRIPTION

7.1 INPUT PANEL (HBT-C6POE-VGA-S) Front Panel

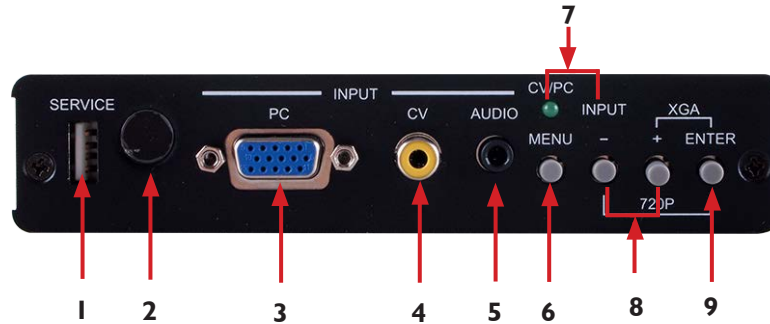

<p>1. SERVICE: Reserved for manufacturer use only.</p>	<p>2. IR RECEIVER WINDOW: Receives only the IR signal from the supplied remote control for this device only.</p>
<p>3. PC: Connect to a PC/Laptop source device with a D-Sub 15pin cable.</p>	<p>4. CV: Connect to a composite video source such as a DVD/Video player.</p>
<p>5. AUDIO: Connect to an analog stereo (L/R) audio source with a 3.5mm mini-jack cable.</p>	<p>6. MENU: This button enters the On-Screen Display (OSD) menu.</p>
<p>7. INPUT (-) Button & CV/PC LED: Press the INPUT (-) button to toggle between CV or PC inputs. When in CV mode the LED will be lit, off when in PC mode.</p>	<p>8. -/+: Use these buttons to navigate down and up in the on-screen menu.</p>
<p>9. ENTER: Press to confirm selection.</p> <p>Note: Pressing '-' (MINUS) and ENTER simultaneously will immediately switch the output resolution of the device to 720p60. Pressing '+' (PLUS) and ENTER simultaneously will immediately switch the output resolution of the device to XGA (1024×768).</p>	



7.2 INPUT PANEL (HBT-C6POE-VGA-S) Back Panel

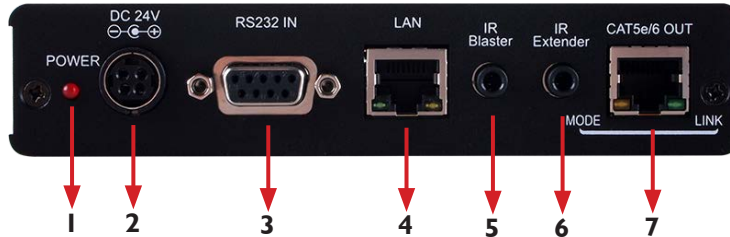

<p>1. POWER LED: This LED will illuminate when the device is connected to an active power supply.</p>	<p>2. DC 24V: Connect the 24 V DC power supply to the unit and plug the adaptor into an AC outlet. Only one unit requires powering if both the Transmitter and Receiver are both PoE compatible.</p>
<p>3. RS-232 IN: Connect to a PC or RS-232 control system with a D-Sub 9 pin male cable for the transmission of RS-232 commands.</p>	<p>4. LAN: Connect to an active network for LAN serving. When any compatible LAN equipped receivers are connected, this allows the network access (including internet access if available) to be shared between any connected LAN equipped receivers. Connect any Ethernet equipped device e.g. a Smart TV or games console to the LAN port of a receiver for that device to share the network/internet access.</p>
<p>5. IR Blaster: Connect the supplied IR Blaster cable for IR signal transmission. Place the IR Blaster in direct line-of-sight of the equipment to be controlled.</p>	<p>6. IR Extender: Connect the supplied IR Receiver cables for IR signal reception. Ensure that remote being used is within the direct lineof-sight of the IR Extender.</p>
<p>7. CAT5e/6/7 OUT: Connect to the Receiver unit with a single CAT5e/6/7 cable for transmission of all data signals. MODE LED: This LED will illuminate when the power is connected. LINK LED: This LED will illuminate when connected to a Receiver unit that is connected with a TV/monitor that is displaying the signal.</p>	

7.3 REMOTE CONTROL

- 1 INPUT:** Press this button to toggle between the CV or PC input.
- 2 EXIT:** Press this button to exit the menu or the current selection in the on-screen menu.
- 3 MENU:** Press this button to enter into the OSD menu.
- 4 RESET:** Press this button to return the device to the factory default settings.
- 5 AUTO ADJUST:** Press this button to optimize the positioning of the picture (picture centering) on the screen.
- 6 OK & ▲▼◀▶:** Press 'OK' to confirm the selection or use the directional buttons to navigate the on-screen menus.

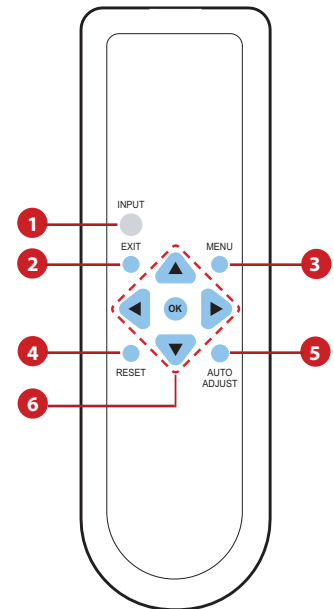

7.4 IR Cable Pin Assignment

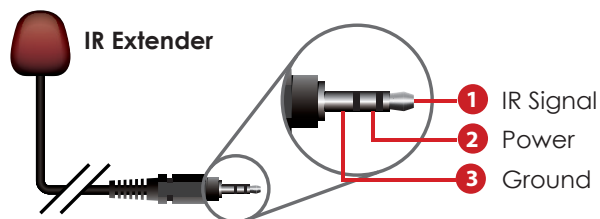
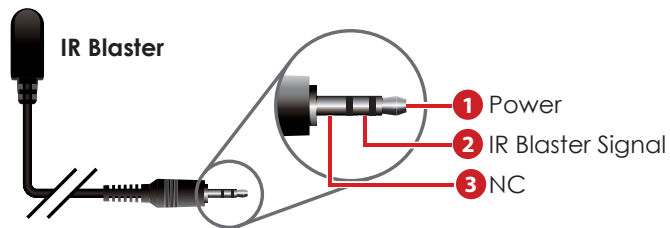

8. RS-232 PIN DEFINITIONS

PIN	DEFINE TX / RX
1	N/C
2	TxD/RxD
3	RxD/TxD
4	NC
5	GND
6	NC
7	NC
8	NC
9	NC

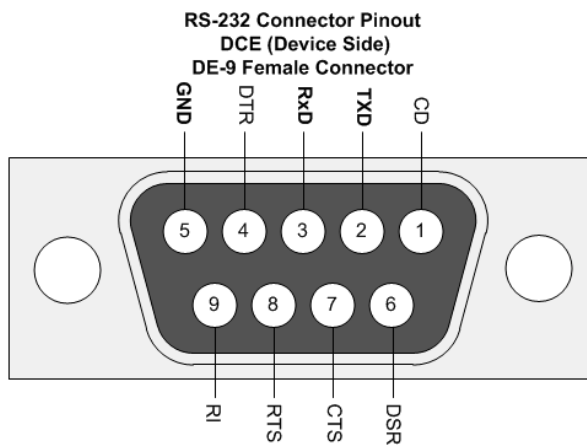
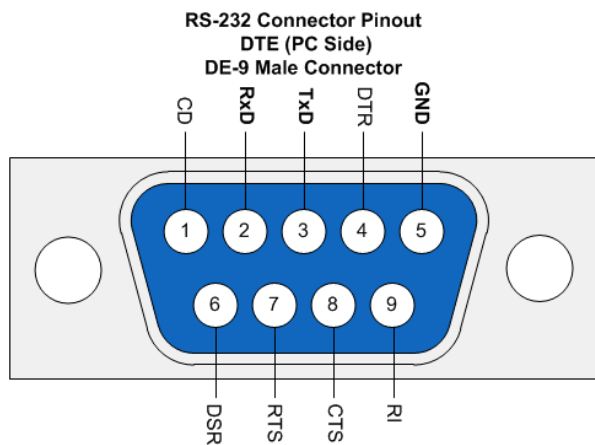

RS-232 SETTINGS

Baud Rate: 9600bps
 Data Bit: 8 bits parity:
 None
 Flow Control: None
 Stop Bit: 1



9. RS-232 COMMANDS

COMMAND	DESCRIPTION
S SOURCE 1~2	1=VIDEO 2=PC
R SOURCE	Reports the numerical equivalent for the SOURCE setting (as listed above)
S OUTPUT 0~25	0=Native 1=640×480 2=800×600 3=1024×768 5=1360×768 6=1280×720 7=1280×800 8=1280×1024 9=1440×900 10=1400×1050 11=1680×1050 12=1600×1200 13=1920×1080 16=1920×1200 17=480p 18=720p@60 19=1080p@60 20=1080i@60 22=576p 23=720p@50 24=1080p@50 25=1080i@50
R OUTPUT	Reports the numerical equivalent for the OUTPUT setting (as listed above)
S SIZE 0~6	0=OVERSCAN 1=FULL 2=BEST FIT 3=PAN SCAN 4=LETTER BOX 5=UNDER 2 6=UNDER 1
R SIZE	Reports the numerical equivalent for the SIZE setting (as listed above)
S CONTRAST 0~60	Sets the numerical value for the CONTRAST setting (0~60)
R CONTRAST	Reports the numerical value for the CONTRAST setting (0~60)
S BRIGHTNESS 0~60	Sets the numerical value for the BRIGHTNESS setting (0~60)
R BRIGHTNESS	Reports the numerical value for the BRIGHTNESS setting (0~60)



COMMAND	DESCRIPTION
S HUE 0~60	Sets the numerical value for the HUE setting (0~60)
R HUE	Reports the numerical value for the HUE setting (0~60)
S SATURATION 0~60	Sets the numerical value for the SATURATION setting (0~60)
R SATURATION	Reports the numerical value for the SATURATION setting (0~60)
S SHARPNESS 0~30	Sets the numerical value for SHARPNESS setting (0~30)
R SHARPNESS	Reports the numerical value for the SHARPNESS setting (0~30)
S NR 0~3	0=OFF 2=MIDDLE 1=LOW 3=HIGH
R NR	Reports the numerical equivalent for the NOISE REDUCTION setting (as listed above)
S AUDIO DELAY 0~3	0=OFF 2=110ms 1=40ms 3=150ms
R AUDIO DELAY	Reports the numerical equivalent for the AUDIO DELAY setting (as listed above)
S AUDIO MUTE 0/1	0=ON 1=MUTE
R AUDIO MUTE	Reports the numerical equivalent for the AUDIO MUTE setting (as above)
S KEY LOCK 0/1	0=ENABLE 1=DISABLE
R KEY LOCK	Reports the numeric equivalent for the KEY LOCK setting (as listed above)
FW	Checks the FIRMWARE version
S RESET 1	Sets the numerical equivalent for the RESET setting (as left)

Note:

1. RS-232 commands will not execute unless followed by a carriage return and LF (Line Feed).
2. Commands are not case-sensitive.
3. Resolutions 1~16 are RGB encoded and 17~25 are YUV encoded.



10. OSD MENU

1 ST LAYER	2 ND LAYER	3 RD LAYER	4 TH LAYER
DISPLAY	OUTPUT	Native	
		640x480 60	
		800x600 60	
		1024x768 60	
		1360x768 60	
		1280x720 60	
		1280x800 60	
		1280x1024 60	
		1440x900 60	
		1400x1050 60	
		1680x1050 60	
		1600x1200 60	
		1920x1080 60	
		1920x1200 60	
		720x480P 60	
		1280x720P 60	
		1920x1080I 60	
		1920x1080P 60	
		720x576P 50	
		1280x720P 50	
		1920x1080I 50	
		1920x1080P 50	
SIZE	SIZE	OVER SCAN	
		FULL	
		ASPECT RATIO	
		PAN SCAN	
		LETTER BOX	
		UNDER 2	
		UNDER 1	



1 ST LAYER	2 ND LAYER	3 RD LAYER	4 TH LAYER
SIZE	MODE INFO	INFO	
		ON	
		OFF	
	PC (PC mode only)	AUTO SETUP	NO
			YES
		H_POSITION	0~60 (30)
		V_POSITION	0~60 (30)
		PHASE	
		CLOCK	
		WXGA/XGA	XGA
			WXGA
	RESET	NO	
		YES	
COLOR	COLOR	R	
		G	
		B	
		R OFFSET	
		G OFFSET	
		B OFFSET	
	CONTRAST	0~60	
	BRIGHTNESS	0~60	
	HUE	0~600~60	
	SATURATION	0~60	
	SHARPNESS	0~60	
	NR.	OFF	
		LOW	
		MIDDLE	
		HIGH	



1 ST LAYER	2 ND LAYER	3 RD LAYER	4 TH LAYER
AUDIO	VOLUME	0~100	
	DELAY	OFF	
		40ms	
		110ms	
		150ms	
	SOUND	ON	
		MUTE	
SETUP	FACTORY RESET	NO	
		YES	
	KEY LOCK	OFF	
		ON	
INFORMATION	INPUT		
	OUTPUT		
	REVISION		

Note: Items in **Bold** are the default settings.

11. Input Resolutions Support

INPUT RESOLUTION	CV	PC
NTSC/PAL	✓	-
VGA@60/72/75 Hz	-	✓
SVGA@56/60/72/75 Hz	-	✓
XGA@60/70/75 Hz	-	✓
SXGA@60/75 Hz	-	✓
UXGA@60 Hz	-	✓
1280×800@60 Hz	-	✓
1680×1050@60 Hz (RB)	-	✓
1920×1080@60 Hz	-	✓





12. INSTALLATION(HBT-C6POE-VGA-S)

To setup Avenview HBT-C6POE-VGA-S please follow these steps for connecting to a device:

1. Power off all sources such as media player, set-top box, PC etc;
2. Connect VGA video Source to the VGA INPUT of (HBT-C6POE-VGA-S);
3. Connect HBT-C6POE-VGA-S to HBT-C6POE-R with a CAT5e/6 at the CAT5e/6 OUT;
4. Connect HBT-C6POE-R to TV/Monitor with HDMI Cable;
5. Plug in 24V/2.7A DC power adapter to power jack of HBT-C6POE-VGA-S;
6. Power on VGA Source and TV/MONITOR;
7. When the Input is connected and turned on the corresponding POWER LED will light.

13. GENERAL TROUBLESHOOTING

PROBLEM	POSSIBLE SOLUTION
NO IMAGE	<ul style="list-style-type: none"> • Check if connection to the source and the display are correct. • Ensure that display device supports resolution from 640 up to 1080p. • Please use the supplied power supply-24V DC • Check LED light Mode / Link lights on the CAT5E/6 connector MODE LED: This LED will illuminate when the power is connected. LINK LED: This LED will illuminate when connected to a Receiver unit that is connected with a TV/monitor that is displaying the video and audio signal. • Check INPUT (-) Button & CV/PC LED: Press the INPUT (-) button to toggle between CV or PC inputs. When in CV mode the LED will be on, LED off when in PC mode. (Section 3 Panel Description)

Please use the supplied power supply-24V DC



14. SPECIFICATIONS

Item	Description
UNITS	HBT-C6POE-VGA-S
UNIT DESCRIPTION	HDBaseT™ Transmitter Scaler
OUTPUT BANDWIDTH	300MHz / 10.2Gbps
CV RESOLUTION SUPPORT	NTSC/PAL
VGA RESOLUTION SUPPORT	VGA~WUXGA (RB)
CAT5 RESOLUTION SUPPORT	4HD: Up to 1080p@60 Hz / PC: Up to WUXGA (RB)
IR FREQUENCY	30~50 kHz
INPUT	1×Composite Video, 1×VGA, 1×3.5mm, Mini-jack (L/R), 1×RS-232, 1×LAN, 1×IR Extender
OUTPUT	1×CAT5e/6/7, 1×IR Blaster
DIMENSIONS (WxDxH)	7.9" x 5.7" x 1.2" (Jacks Included)
NET WEIGHT	1.33lbs
POWER SUPPLY	24V/2.7A DC / 110-240V
POWER CONSUMPTION	16W
ESD PROTECTION	Human body model - ±15kV (air gap discharge) & ±8kV (contact discharge)
<i>Environmental</i>	
OPERATING TEMPERATURE	32° ~ 104°F (0° to 40°C)
STORAGE TEMPERATURE	-4° ~ 140°F (-20° ~ 60°C)
RELATIVE HUMIDITY	20~90% RH (non-condensing)



Avenview Warranty Certificate

AVENVIEW CORP. ("Avenview") warrants Avenview-branded product(s) contained in the original packaging against defects in materials and workmanship when used normally in accordance with Avenview's enclosed manual guidelines for a period of THREE (3) YEARS from the date of original retail purchase - Warranty Period. Avenview's published guidelines include but are not limited to information contained in technical specifications, user manuals and service communications.

LABOR: During the Warranty Period of THREE (3) YEARS, Avenview will repair or replace the product(s) at no cost using new or used parts equivalent to novel performance and reliability if the product(s) is determined to have abide by Avenview's published guidelines. Cost of Labor applicable to product(s) after Warranty Period. For labor costs, please contact support@avenview.com.

PARTS: During the Warranty Period of of THREE (3) YEARS, Avenview will supply new or rebuilt replacements in exchange for defective parts of the product(s) at no cost if the product(s) is determined to have abide by Avenview's published guidelines. Cost of Parts applicable to product(s) after Warranty Period. For part(s) costs, please contact support@avenview.com.

To obtain Warranty: (a) proof of purchase in the form of a bill of sale or receipted invoice reflecting that the registered product(s) is within warranty period must be presented to obtain warranty service; (b) product(s) must be registered at time of purchase. Failure to do so will result in applicable parts and labor charges. Returning product(s) must be shipped in Avenview's original packaging or in packaging pertaining equal degree of protection to Avenview's. Both Avenview and purchaser are responsible for freight charges and brokerages when shipping the product(s) to the receiver.

NOT COVERED BY THIS WARRANTY

This warranty does not apply to any non-Avenview branded product(s); non-registered Avenview product(s). This warranty does not apply: (a) to cosmetic damage, including but not limited to scratches, dents and broken cords; (b) to damage caused by use with another product; (c) to damage caused by accident, abuse, misuse, liquid contact, fire, earthquake or other external cause; (d) to damage caused by operating the Avenview product(s) outside Avenview's manuals or guidelines; (e) to damage caused by service performed by anyone who is not a representative of Avenview or an Avenview authorized personnel; (f) to defects caused by normal wear and tear or otherwise due to the normal aging of the Avenview product(s), or (g) if any serial number has been removed or defaced from the Avenview product(s).

AVENVIEW IS NOT LIABLE FOR DIRECT, SPECIAL, INCIDENTAL OR CONSEQUENTIAL DAMAGES RESULTING FROM ANY BREACH OF WARRANTY OR CONDITION, OR UNDER ANY OTHER LEGAL THEORY, INCLUDING BUT NOT LIMITED TO LOSS OF USE; LOSS OF REVENUE; LOSS OF ACTUAL OR ANTICIPATED PROFITS (INCLUDING LOSS OF PROFITS ON CONTRACTS); LOSS OF THE USE OF MONEY; LOSS OF ANTICIPATED SAVINGS; LOSS OF BUSINESS; LOSS OF OPPORTUNITY; LOSS OF GOODWILL; LOSS OF REPUTATION; LOSS OF, DAMAGE TO, COMPROMISE OR CORRUPTION OF DATA; OR ANY INDIRECT OR CONSEQUENTIAL LOSS OR DAMAGE REPAIR OR REPLACEMENT AS PROVIDED UNDER THIS WARRANTY IS THE EXCLUSIVE REMEDY OF THE CONSUMER.

Some states do not allow the inclusion or limitation of incidental or consequential damages, or allow limitations on duration implements of the Warranty Period; therefore the above limitations or exclusions may not be applicable to you. This warranty gives you specific legal rights, and you may have other rights which vary from state to state.



275 Woodward Avenue, Kenmore, NY 14217
1.866.508.0269





Control Your Video

TECHNICAL SUPPORT

CONTACT US



Phone: 1 (866) 508 0269



Email: support@avenview.com



USA Head Office Avenview Corp. 275 Woodward Avenue Kenmore, NY 14217

Avenview USA

Avenview Head Office
275 Woodward Avenue
Kenmore, NY 14217
Phone: 1.716.218.4100
Fax: 1.866.387.8764
Email: info@avenview.com

Avenview Canada

Avenview Sales
151 Esna Park Drive, Units 11 & 12
Markham, ON, L3R 3B1
Phone: 1.905.907.0525
Fax: 1.866.387.8764
Email: info@avenview.com

Avenview Europe

Avenview Europe
Demkaweg 11
3555 HW Utrecht
Netherlands
Phone: +31(0)85.2100.613
Email: info@avenview.eu

Avenview Hong Kong

Unit 8, 6/F, Kwai Cheong Centre,
50 Kwai Cheong Road,
Kwai Chung, N.T.
Hong Kong
Phone: 852.3575.9585
Email: asia@avenview.com

Disclaimer

While every precaution has been taken in the preparation of this document, Avenview Inc. assumes no liability with respect to the operation or use of Avenview hardware, software or other products and documentation described herein, for any act or omission of Avenview concerning such products or this documentation, for any interruption of service, loss or interruption of business, loss of anticipatory profits, or for punitive, incidental or consequential damages in connection with the furnishing, performance, or use of the Avenview hardware, software, or other products and documentation provided herein.

Avenview Inc. reserves the right to make changes without further notice to a product or system described herein to improve reliability, function or design. With respect to Avenview products which this document relates, Avenview disclaims all express or implied warranties regarding such products, including but not limited to, the implied warranties of merchantability, fitness for a particular purpose, and non-infringement.