



AV Connectivity, Distribution And Beyond...

**VIDEO WALLS VIDEO PROCESSORS  
VIDEO MATRIX SWITCHES  
EXTENDERS SPLITTERS WIRELESS  
CABLES & ACCESSORIES**

## **HDBaseT HDMI Wall Plate Receiver IR/RS232/POE 100M**



**Model #: HBT-C6POEWP-R**

© 2013 Avenview Inc. All rights reserved.

The contents of this document are provided in connection with Avenview Inc. ("Avenview") products. Avenview makes no representations or warranties with respect to the accuracy or completeness of the contents of this publication and reserves the right to make changes to specifications and product descriptions at any time without notice. No license, whether express, implied, or otherwise, to any intellectual property rights is granted by this publication. Except as set forth in Avenview Standard Terms and Conditions of Sale, Avenview assumes no liability whatsoever, and claims any express or implied warranty, relating to its products are strictly prohibited.

## Product Application & Market Sectors



Corporate



House Of Worship



Military



Residential



Education



Industrial



Medical



Aviation



## TABLE OF CONTENTS

1.	GETTING STARTED .....	1
1.1	IMPORTANT SAFEGUARDS.....	1
1.2	SAFETY INSTRUCTIONS .....	1
1.3	REGULATORY NOTICES FEDERAL COMMUNICATIONS COMMISSION (FCC) .....	2
2.	INTRODUCTION .....	3
2.1	PACKAGE CONTENTS .....	4
2.2	BEFORE INSTALLATION.....	5
2.2	CABLE SPECIFICATIONS .....	5
2.3	APPLICATION DIAGRAM.....	6
2.4	PANEL DESCRIPTION.....	7
2.4.1	INPUT PANEL (HBT-C6POEWP-R) FRONT PANEL .....	7
2.4.2	INPUT PANEL (HBT-C6POEWP-R) Rear Panel .....	7
3.	INSTALLATION (HBT-C6POEWP-R).....	8
4.	IR CABLE DEFINITION.....	9
5.	GENERAL TROUBLESHOOTING.....	10
6.	SPECIFICATIONS .....	11
	NOTICE.....	12



## SECTION I: GETTING STARTED

### I.1 IMPORTANT SAFEGUARDS

Please read all of these instructions carefully before you use the device. Save this manual for future reference.

#### What the warranty does not cover

- Any product, on which the serial number has been defaced, modified or removed.
- Damage, deterioration or malfunction resulting from:
- Accident, misuse, neglect, fire, water, lightning, or other acts of nature, unauthorized product modification, or failure to follow instructions supplied with the product.
- Repair or attempted repair by anyone not authorized by us.
- Any damage of the product due to shipment.
- Removal or installation of the product.
- External causes to the product, such as electric power fluctuation or failure.
- Use of supplies or parts not meeting our specifications.
- Normal wear and tear.
- Any other causes which does not relate to a product defect.
- Removal, installation, and set-up service charges.

### I.2 SAFETY INSTRUCTIONS

The HBT-C6POEWP-R HDBaseT HDMI Wall plate Receiver has been tested for conformance to safety regulations and requirements, and has been certified for international use. However, like all electronic equipments, the HBT-C6POEWP-R should be used with care. Read the following safety instructions to protect yourself from possible injury and to minimize the risk of damage to the unit.



- ⚠ Do not dismantle the housing or modify the module.
- ⚠ Dismantling the housing or modifying the module may result in electrical shock or burn.
- ⚠ Refer all servicing to qualified service personnel.
- ⚠ Do not attempt to service this product yourself as opening or removing housing may expose you to dangerous voltage or other hazards
- ⚠ Keep the module away from liquids.
- ⚠ Spillage into the housing may result in fire, electrical shock, or equipment damage. If an object or liquid falls or spills on to the housing, unplug the module immediately.
- ⚠ Have the module checked by a qualified service engineer before using it again.
- ⚠ Do not use liquid or aerosol cleaners to clean this unit. Always unplug the power to the device before cleaning.



## 1.3 REGULATORY NOTICES FEDERAL COMMUNICATIONS COMMISSION (FCC)

This equipment has been tested and found to comply with Part 15 of the FCC rules. These limits are designed to provide reasonable protection against harmful interference in a residential installation.

Any changes or modifications made to this equipment may void the user's authority to operate this equipment.

Warning symbols	Description
	<p>ONLY USE THE PROVIDED POWER CABLE OR POWER ADAPTER SUPPLIED. DO NOT TAMPER WITH THE ELECTRICAL PARTS. THIS MAY RESULT IN ELECTRICAL SHOCK OR BURN.</p>
	<p>DO NOT TAMPER WITH THE UNIT. DOING SO WILL VOID THE WARRANTY AND CONTINUED USE OF THE PRODUCT.</p>
	<p>THE VIDEO BOARDS ARE VERY SENSITIVE TO STATIC. PLEASE ENSURE IF RACK MOUNTED OR INSTALLED ON A SURFACE, IT SHOULD BE IN A GROUNDED ENVIROMENT.</p>

	<p><b>⚠ WARNING</b></p>
	<p>Read &amp; understand user guide before using this device.</p> <p>Failure to follow the proper installation instructions could result in damage to the product and preventing expected results.</p>



## 2. INTRODUCTION

The Avenview HBT-C6POEWP-R HDBaseT HDMI wall plate receiver was developed to simplify the install and also create a clean seamless look with the decor. Accepts the transmitted HDMI signal over Single CAT5e/6 from the TX of uncompressed audio/video, data control through the built-in RS-232 and IR ports. No need to power this unit because the TX wall plate supplies Power on Ethernet (PoE) over the CAT5/6 to this Receiver wall plate extending all signals up to 100m to the display screen. With this unique wall plate design integration within your solution has never been this simple.

**Video Signals** - Supports Full HD 1080p up to 3D, 2K (2160 x 1440), UHD (3840 x 2160)

**Audio Signals** - Pass-through up to LPCM 7.1CH, Dolby TrueHD, and DTS-HD Master Audio

**Data Signals** - RS-232 and bi directional IR IN and IR OUT ports

The HBT-C6POEWP-R includes one unit: A 2 Gang Wall plate HDBaseT HDMI Receiver with one (1) HDMI Input and one (1) HDBaseT RJ45 module Output.

### Features

- HDMI 1.4 with 3D, 4k x 2k support, HDCP & DVI Compliant
- HDCP repeater and CEC bypass
- Receive uncompressed data signals over a single CAT6 or CAT5e cable Up to 100M/328ft
- Video: Uncompressed video 1080p, 60Hz, 36bits
- Audio up to 7.1CH & Dolby TrueHD, DTS-HD
- HDBaseT 4Play™ convergence: HDMI, POE & Control (IR & RS232)

This system was tested with CAT6A (625MHz), 4-Pair, U/UTP-Unshielded cable, so if using Category cables of another type, results may vary.

- NOTE: The PoE function is designed for powering compatible Receiver units only. The non-PoE Receivers has to be powered with a power supply. Transmitters (Tx) from different manufactures would not be compatible. Displaying HDMI 4Kx2K resolution would require the standard 4Kx2K HDMI cable and display for accurate results



## 2.1 PACKAGE CONTENTS

Before you start the installation of the HDMI Extender, please check the package contents.

1	HBT-C6POEWP-R X 1	
2	IR EXTENDER	
	IR BLASTER	
	USER'S MANUAL	



## 2.2 BEFORE INSTALLATION

- Put the product in a level and stable location. If the product falls, it may cause damage or malfunction to components within the casing.
- Do not place the product in temperatures under 0°C or over 50°C. High humidity may also cause the unit to malfunction.
- Use the DC power adapter with correct specifications supplied with the unit. If the improper power supply is used, this may result in malfunction of the unit and may cause fire.
- Do not twist or pull by force the ends of the UTP cable. It will cause malfunction.

## 2.2 CABLE SPECIFICATIONS



We highly recommend achieving best results with our HBT-C6POEWP-R you acquire a high quality 26 or 24 AWG HDMI cable with the below specifications to maintain signal integrity and distances.

### Features

- Length: 5m (16ft) to 15m (50ft)
- Bandwidth: 10.2 Gbps data transfer rate
- Supports Resolution: Up to 3840x2160 @ 24Hz and 4096x2160 @ 24Hz, 1080p @ 24Hz / 50/60Hz/3D
- Conductor gauge: 26 / 24 AWG
- Deep Color
- 3D Capable
- CEC
- Ethernet Channel
- Audio Return Channel
- Connector 1: HDMI (Type A) Male
- Connector 2: HDMI (Type A) Male





## 2.3 APPLICATION DIAGRAM

### HBT-C6POEWP-SET

- CABLE INDEX**
- CAT5/6 CABLE
  - Input / Source
  - RS-232
  - LAN /INTERNET

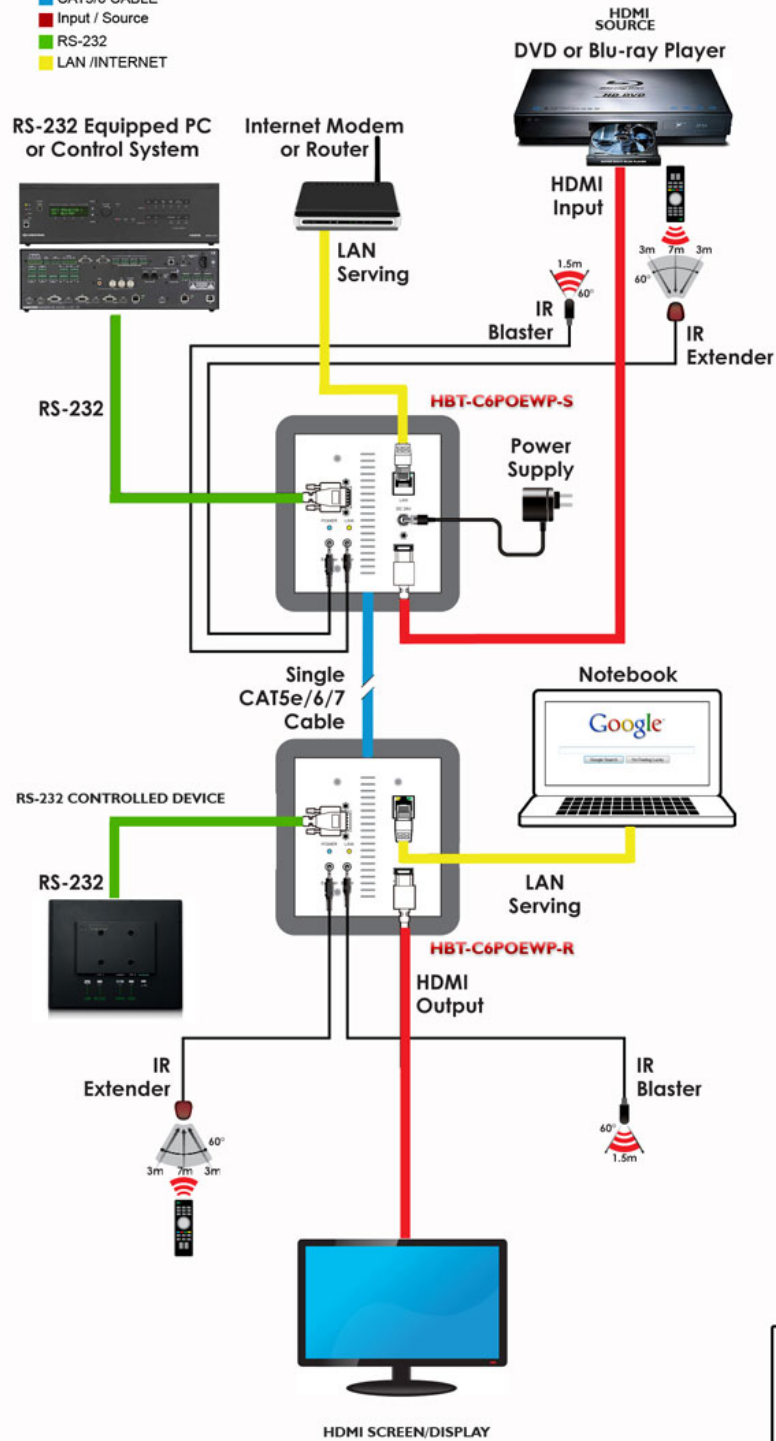

## 2.4 PANEL DESCRIPTION

### 2.4.1 INPUT PANEL (HBT-C6POEWP-R) Front Panel

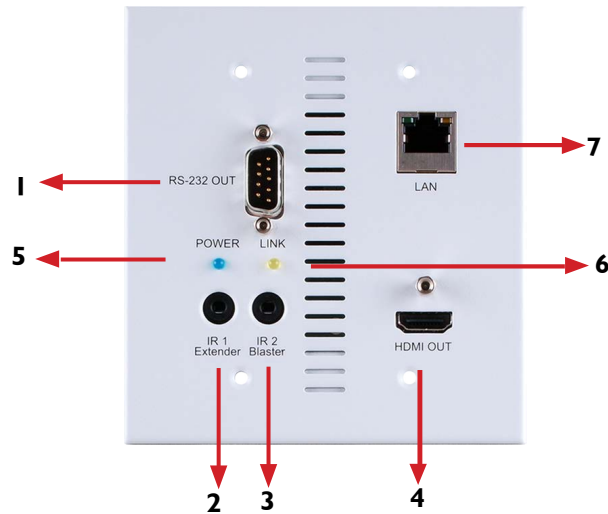

- |  |
|--|
| 1. RS-232 OUT: Connect using the 3.5mm jack to RS232 Cable to devices that receives RS232 Commands                   |
| 2. IR 1 IN: Connect the IR Receiver cable included to receive IR Signal.   |
| 3. IR 2 OUT: Connect the IR blaster cable included to transmit IR Signal.  |
| 4. HDMI OUT: Connect with HDMI male cable to display audio/video signal to screen                                    |
| 5. Power LED: BlueLED will illuminate when the supplied power supply is attached.                                    |
| 6. LINK LED: Yellow LED will illuminate when input and output signal is detected over the CAT5/6 cable when attached |
| 7. CAT5/6 LAN OUT: Connect to LAN Supported Output Devices   |

### 2.4.2 INPUT PANEL (HBT-C6POEWP-R) Rear Panel



- |  |
|--|
| 8. CAT5/6 IN: Connect to a compatible Transmitter unit to receive video/audio/data signals |
|--|





### 3. INSTALLATION (HBT-C6POEWP-R)

To setup Avenview HBT-C6POEWP-R please follow these steps for connecting to a device:

1. Power off sources such as using Laptop/PC DVD player at Podium or where installed.
2. Connect HDMI video Source to the HDMI INPUT on the compatible TX- up to with Full HD, 3D and 4k x 2k support
3. Connect CAT 5/6 OUT to a compatible HBT-C6POEWP-R (Rx) CAT 5/6 IN and HDMI cable to HDMI Displays
4. Power on HDMI Source and HDMI Display
5. When the Input is connected and turned on the corresponding Yellow LED will light on the LINK LED when signal is detected and transmitting.

Attaching the Wall Plate Transmitter to a Drywall or Commercial New Construction



## 4. IR CABLE DEFINITION

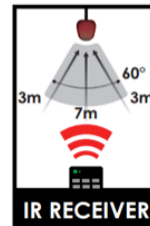
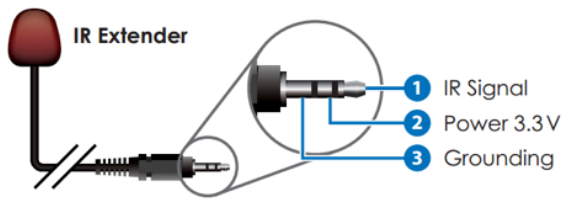
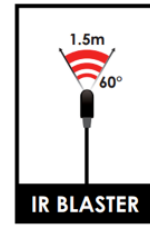
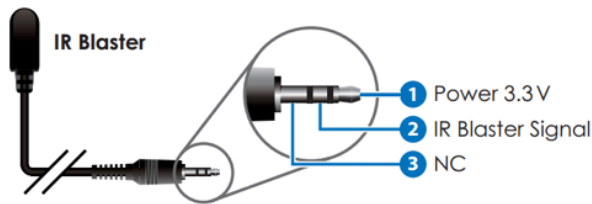

### IR Sockets

**IR BLASTER:** plug in the IR blaster to the HBT-C6POE-R to emit all IR command signals received from the IR Extender plugged into the Rx (Monitor Side) to control the devices corresponding to the IR signals. Example: Set Top Box or DVD player (The Source).

**IR EXTENDER:** plug in the IR Extender into the (RX) Receiver (Monitor Side) to receive all IR command signals from the IR remote controls of the corresponding source.

Example: Set Top Box or DVD player (IR Remote Control).

### 7. D-SUB 9 PIN DEFINITIONS

Pin	Define TX/RX
1	N/C
2	TxD/RxD
3	RxD/TxD
4	N/C
5	GND
6	N/C
7	N/C
8	N/C
9	N/C

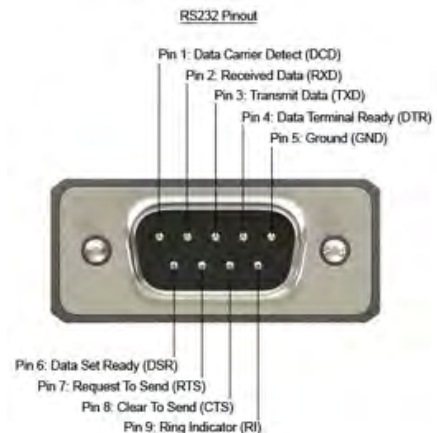

# WARNING

*NOTE: Incorrect placement of IR Blaster and IR Extender into the extender may result in the failure of the IR extenders.*

*Please check carefully before plugging in the IR extender to the respective IR sockets.*



## 5. GENERAL TROUBLESHOOTING

PROBLEM	POSSIBLE SOLUTION
<b>NO IMAGE</b>	<ul style="list-style-type: none"> <li>• Check if connection to the source and the display are correct.</li> <li>• Ensure that display device supports 480p, 720p and 1080p 4K@30 resolution</li> <li>• Terminated to 568B standard with Shielded Ends Recommended</li> <li>• High Quality CAT5/6/7 Cable helps signal transmission</li> <li>• Please use the supplied power supply-DC 24V 2.7A</li> <li>• Check LED Link light see (Section 3 Panel Description)</li> <li>• Check LED Sync light see (Section 3 Panel Description)</li> </ul>
<b>EDID ISSUE</b>	<ul style="list-style-type: none"> <li>• EDID MODE-: The unit will detect the 1st CAT5e/6/7 output's EDID. When obtained a (4K2K) Ultra HD 3840x2160 EDID the signal is transmitted.</li> <li>• If the 1st CAT5e/6/7 output is without a Ultra HD 3840x2160 EDID the unit will detect all output's EDID and Transmit the signal that all outputs can accept.</li> </ul>
<b>SET-TOP BOX NO PICTURE</b>	<ul style="list-style-type: none"> <li>• HDBaseT and HDMI 1.3 standards support CLOCK STRETCHING for i2c buss protocol</li> <li>• Example set top boxes like Scientific Atlantic results no picture. This can be resolved by swapping out the box for a newer version that supports HDMI 1.3 not HDMI 1.2</li> </ul>
<b>NO INFRARED COMMUNICATION</b>	<ul style="list-style-type: none"> <li>• Ensure the UTP cable is run within the wall away from EMI and High Voltage power Lines.</li> <li>• Please check manual of device to ensure proper placement of IR Blaster on IR EYE.</li> <li>• Some LED /Plasma TV have EMI interference with the IR Extender, please place the IR Rx 3-6" away from Screen</li> </ul>
RECOMMENDED TEST	
<b>END-TO-END TESTING</b>	HDBaseT system, a final end-to-end test of all the A/V components should take place. These tests include checking the HDMI stream at the far end (sink end), the clock rate, frame compare, video pattern, audio, EDID and HDCP with Quantum 780 (recommended)
<b>PASSIVE MONITORING:</b>	Passive monitoring enables an integrator to view the HDCP transactions, EDID exchange, as well as the connection events between the actual devices in the network.

Note:

*Additional info on Guidelines to Test & Troubleshoot HDBaseT Systems*

*Can be retrieved from our website under the category Downloads for this product HBT-C6POEWP-R*



## SECTION 7: SPECIFICATIONS

### 6. SPECIFICATIONS

Item	Description
<b>UNITS</b>	HBT-C6POEWP-R
<b>UNIT DESCRIPTION</b>	HDBaseT HDMI Wall Plate Receiver
<b>HDMI COMPLIANCE</b>	YES HDBaseT
<b>HDCP</b>	Yes
<b>VIDEO BANDWIDTH</b>	Single-link 300MHz [9Gbps]
<b>SUPPORTED RESOLUTIONS</b>	480i / 480p / 720p / 1080i / 1080p60 / 4K@30 Up to Ultra HD (3840x2160@24/25/30Hz) 4K2K-(4096x2160@24Hz)
<b>CEC SUPPORT</b>	ALLOWS CEC BYPASS
<b>CAT5/6/7 CABLE</b>	4K2K: (3840X2160@30Hz) ~ 75meter (250feet) (CAT6e) / 100meter (330feet) (CAT6a) FULL HD: (1080p) ~ 100meter (330feet) (CAT6e) / 110meter (360feet) (CAT6a)
<b>AUDIO SUPPORT</b>	LPCM 7.1CH, Dolby TrueHD, Dolby Digital Plus and DTS-HD Master Audio
<b>INPUT TMDS SIGNAL</b>	1.2 Volts (peak-to-peak)
<b>INPUT DDC SIGNAL</b>	5 Volts (peak-to-peak, TTL)
<b>ESD PROTECTION</b>	Human body model — ±8kV (air-gap discharge) & ±4kV (contact discharge)
<b>INPUT</b>	1x 3.5mm IR Extender 1x CAT5/6/7
<b>OUTPUT</b>	1x CAT5/6/7 1x 3.5mm IR 1x HDMI 1x RS232
<b>HDMI CONNECTOR</b>	Type A (19 pin female)
<b>LED</b>	GREEN/YELLOW LED
<b>IR FREQUENCY</b>	30~50kHz
<b>DIMENSIONS (L X W X H)</b>	3.4" x 3.8" x 1.2" 87 mm (L)×97mm (W)×31 mm (H)
<b>WEIGHT</b>	0.8lbs 353g
<b>POWER SUPPLY</b>	PoE from compatible Transmitter (US/EU standards, CE/FCC/UL certified)
<b>POWER CONSUMPTION</b>	6 Watt (max)
<b>ENVIRONMENTAL</b>	
<b>OPERATING TEMPERATURE</b>	32° ~ 104°F (0° to 40°C)
<b>STORAGE TEMPERATURE</b>	-4° ~ 140°F (-20° ~ 60°C)
<b>RELATIVE HUMIDITY</b>	20~90% RH (non-condensing)



## NOTICE

- 1. All HDMI over UTP transmission distances are measured using Belden CAT6A (625MHz), 4-Pair, U/UTP-Unshielded, Riser-CMR, Premise Horizontal Cable, 23 AWG Solid Bare Copper Conductors, Polyolefin Insulation, Patented Double-H spline, Ripcord, PVC Jacket using Quantum 980 signal HDMI Video Generator Module Video Pattern Testing.*
- 2. The transmission length is largely affected by the type of category cables, also the type of HDMI sources, and the type of HDMI display. The testing result shows solid UTP cables (usually in the form of 300m or 1000ft bulk cable) can transmit a lot longer signals than stranded UTP cables (usually in the form of patch cords). Shielded STP connectors are better suit than unshielded UTP connectors. A solid UTP CAT5e cable shows longer transmission length than stranded STP CAT6 cable. For long extension users, solid cables are your only choice.*
- 3. EIA/TIA-568-B termination (T568B) for category cables is recommended for better performance.*
- 4. To reduce the interference among the unshielded twisted pairs of wires in category cable, you can use shielded STP cables with shielded connector to improve EMI problems, which occurs in long transmission.*
- 5. Because the quality of the category cables has the major effects in how long transmission distance will be made and how good is the received display, the actual transmission length is subject to your category cables. For resolution greater than 1080i or 1280x1024, a solid CAT6 cable is the only viable choice.*





AV Connectivity, Distribution And Beyond...

## TECHNICAL SUPPORT

### CONTACT US



Phone: 1 (866) 508 0269



Email: [support@avenview.com](mailto:support@avenview.com)



**USA Head Office** Avenview Corp. 275 Woodward Avenue Kenmore, NY 14217

#### **USA Head Office**

Avenview Corp.  
275 Woodward Avenue  
Kenmore, NY 14217  
Phone: 1.716.218.4100  
Fax: 1.866.387.8764  
Email: [info@avenview.com](mailto:info@avenview.com)

#### **Canada Sales**

Avenview  
151 Esna Park Drive, Units 11 & 12  
Markham, ON, L3R 3B1  
Phone: 1.905.907.0525  
Fax: 1.866.387.8764  
Email: [info@avenview.com](mailto:info@avenview.com)

#### **Avenview Europe**

Avenview Europe  
Demkaweg 11  
3555 HW Utrecht  
Netherlands  
Phone: +31(0)85.2100.613  
Email: [info@avenview.eu](mailto:info@avenview.eu)

#### **Avenview Hong Kong**

Unit 8, 6/F, Kwai Cheong Centre,  
50 Kwai Cheong Road,  
Kwai Chung, N.T.  
Hong Kong  
Phone: 852.3575.9585  
Email: [asia@avenview.com](mailto:asia@avenview.com)

#### **Disclaimer**

While every precaution has been taken in the preparation of this document, Avenview Inc. assumes no liability with respect to the operation or use of Avenview hardware, software or other products and documentation described herein, for any act or omission of Avenview concerning such products or this documentation, for any interruption of service, loss or interruption of business, loss of anticipatory profits, or for punitive, incidental or consequential damages in connection with the furnishing, performance, or use of the Avenview hardware, software, or other products and documentation provided herein.

Avenview Inc. reserves the right to make changes without further notice to a product or system described herein to improve reliability, function or design. With respect to Avenview products which this document relates, Avenview disclaims all express or implied warranties regarding such products, including but not limited to, the implied warranties of merchantability, fitness for a particular purpose, and non-infringement.