

RKVM Dslide Series

User's Guide



Models

RKVM-17-Mouse

- 1U 17" Screen Size

Use of a true option mouse

© 2007 **Avenview Inc.** All rights reserved.

The contents of this document are provided in connection with Avenview Inc. ("Avenview") products. Avenview makes no representations or warranties with respect to the accuracy or completeness of the contents of this publication and reserves the right to make changes to specifications and product descriptions at any time without notice. No license, whether express, implied, or otherwise, to any intellectual property rights is granted by this publication. Except as set forth in Avenview Standard Terms and Conditions of Sale, Avenview assumes no liability whatsoever, and disclaims any express or implied warranty, relating to its products including, but not limited to, the implied warranty of merchantability, fitness for a particular purpose, or infringement of any intellectual property right.

Reproduction of this manual, or parts thereof, in any form, without the express written permission of Avenview Inc. is strictly prohibited.

Table of Contents

Section 1 – Getting Started	4
1.1 Important Safegaurds	4
1.2 Safety Instructions	5
1.3 Regulatory Notices Federal Communications Commission (FCC)	5
1.4 Package Contents.....	6
1.5 Before Installation.....	7
1.6 Unpacking	Error! Bookmark not defined.
1.7 Optional Accessories.....	7
1.8 Peripheral Products	8
1.9 Structure Diagram.....	8
1.10 Installation	9
1.11 How to Use The Slides	Error! Bookmark not defined.
1.12 Locking Bracket for RKVM-17-Dslide	Error! Bookmark not defined.
1.13 How to use the Dual Slides	Error! Bookmark not defined.
1.14 Connect to Server via USB Interface.....	10
1.15 Connect to KVM via USB Interface	10
1.16 Connect to Server via PS/2 Interface.....	11
1.17 Connect to KVM via PS/2 Interface.....	11
Section 2: Operations.....	12
2.1 On-screen Display Operation.....	12
2.2 On-screen Menu	13
Section 3: Specifications.....	15
3.1 Keyboard & Mouse	16
Section 4: Optional Specifications.....	17
4.1 KVM Options.....	17
4.2 DVI-D Option.....	17
4.3 S-Video + RCA Input Option	17

4.4	S-Video + BNC Input Option.....	18
4.5	DC Power Option	19
	Section 5: Troubleshooting	20
	Section 6: Dimensions.....	20

Section 1 – Getting Started

1.1 Important Safegaurds

Please read all of these instructions carefully before you use the device. Save this manual for future reference.

What the warranty does not cover

- Any product, on which the serial number has been defaced, modified or removed.
- Damage, deterioration or malfunction resulting from:
 - Accident, misuse, neglect, fire, water, lightning, or other acts of nature, unauthorized product modification, or failure to follow instructions supplied with the product.
 - Repair or attempted repair by anyone not authorized by us.
 - Any damage of the product due to shipment.
 - Removal or installation of the product.
 - Causes external to the product, such as electric power fluctuation or failure.
 - Use of supplies or parts not meeting our specifications.
 - Normal wear and tear.
 - Any other causes which does not relate to a product defect.
- Removal, installation, and set-up service charges.

1.2 Safety Instructions

- Unplug equipment before cleaning. Don't use liquid or spray detergent; use a moist cloth.
- Keep equipment away from excessive humidity and heat. Preferably, keep it in an air-conditioned environment with temperatures not exceeding 40° C (104° F).
- When installing, place the equipment on a sturdy, level surface to prevent it from accidentally falling and causing damage to other equipment or injury to persons nearby.
- When the drawer is in an open position, do not cover, block or in any way obstruct the gap between it and the power supply. Proper air convection is necessary to keep it from overheating.
- Arrange the equipment's power cord in such a way that others won't trip or fall over it.
- If you are using a power cord that didn't ship with the equipment, ensure that it is rated for the voltage and current labelled on the equipment's electrical ratings label. The voltage rating on the cord should be higher than the one listed on the equipment's ratings label.
- Observe all precautions and warnings attached to the equipment.
- If you don't intend on using the equipment for a long time, disconnect it from the power outlet to prevent being damaged by transient over-voltage.
- Keep all liquids away from the equipment to minimize the risk of accidental spillage. Liquid spilled on to the power supply or on other hardware may cause damage, fire or electrical shock.
- Only qualified service personnel should open the chassis. Opening it yourself could damage the equipment and invalidate its warranty.
- If any part of the equipment becomes damaged or stops functioning, have it checked by qualified service personnel.

1.3 Regulatory Notices Federal Communications Commission (FCC)

This equipment has been tested and found to comply with the limits for a Class B digital device, pursuant to Part 15 of the FCC rules. These limits are designed to provide reasonable protection against harmful interference in a residential installation.

Any changes or modifications made to this equipment may void the user's authority to operate this equipment.

This equipment generates, uses, and can radiate radio frequency energy and, if not installed and used in accordance with the instructions, may cause harmful interference to radio communications.

However, there is no guarantee that interference will not occur in a particular installation. If this equipment does cause harmful interference to radio or television reception, which can be determined by turning the equipment off and on, the user is encouraged to try to correct the interference by one or more of the following measures:

- Re-position or relocate the receiving antenna.
- Increase the separation between the equipment and receiver.
- Connect the equipment into an outlet on a circuit different from that to which the receiver is connected.

1.4 Package Contents

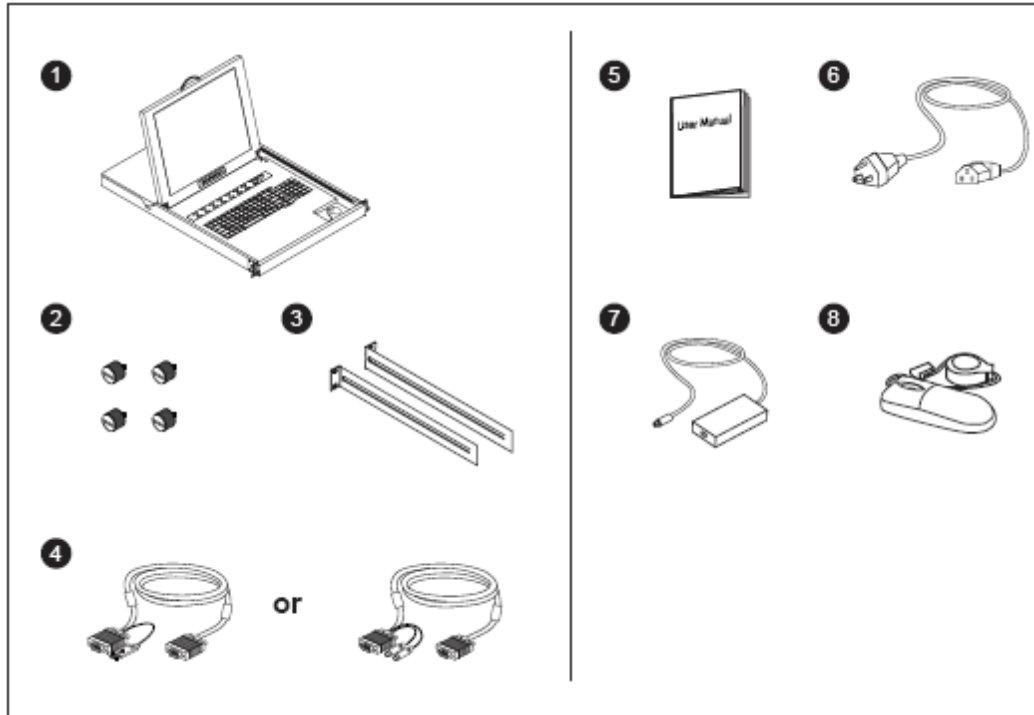

- ① LCD Keyboard drawer x 1 pc,
- ② Fasteners for rear L-bracket x 4 pcs
- ③ 330mm rear mounting L-bracket x 1 pair
 - Mounting depth-adjustable from 390mm to 920mm
- ④ CB-6 2-in-1 USB keyboard cable x 1 pc **or**
CD-6 3-in-1 PS/2 keyboard cable x 1 pc
- ⑤ User manual x 1 pc
- ⑥ Power cord x 1 pc
- ⑦ Auto Switch power adapter (for external power version) x 1 pc
- ⑧ WOM-01 Mini Option Mouse x 1pc

1.5

1.6 Before Installation

- It is very important to locate the Rackmount LCD Keyboard Drawer in a suitable environment.
- The surface for placing and fixing the Rackmount LCD Keyboard Drawer should be stable and level or mounted into a suitable cabinet.
- Make sure the place has good ventilation, is out of direct sunlight, away from sources of excessive dust, dirt, heat, water, moisture and vibration.
- Convenience for connecting the Rackmount LCD Keyboard Drawer to the related facilities should be well considers too.

1.7 Optional Accessories

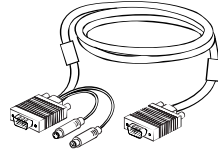
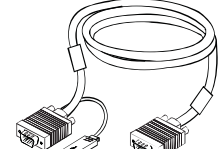
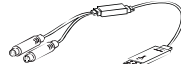
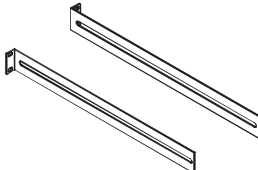
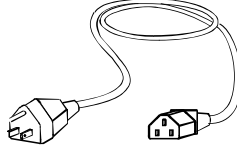
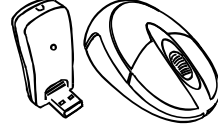
<p>PS/2 3-in-1 KVM cable</p> <p>CD-6 6 feet CD-10 10 feet CD-15 15 feet CD-33 33 feet</p>	
<p>USB 2-in-1 KVM cable</p> <p>CB-6 6 feet CB-10 10 feet CB-15 15 feet</p>	
<p>SUN / iMAC USB to PS/2 adapter</p> <p>SUN-31</p>	
<p>Extended rear mounting L-bracket</p> <p>430mm (16.9") extended rear L-bracket up to 1020mm *Extended rear L-bracket in tailor-made length on request</p>	
<p>Power Cord</p> <p>IEC power cord NEMA 5-15 power cord (US) BS 1363 power cord (UK) CEE 7/4 power cord (German) AS 3112 power cord (Australia)</p>	
<p>Wireless USB Option Mouse</p> <p>WOM-02</p>	

1.8 Peripheral Products

Item	Description
DB-15 KVM	8 / 16-port IP PS/2 KVM 8 / 16-port two console PS/2 KVM 4 / 8 / 16-port PS/2 KVM 8 / 16-port USB KVM
Cat5 KVM	16 / 32-port IP Cat5 KVM 16 / 32-port two console Cat5 KVM 16 / 32-port high density Cat5 KVM
KVM Extender	IP KVM extender Cat5 PS/2 KVM Extender Cat5 USB KVM Extender

1.9 Structure Diagram

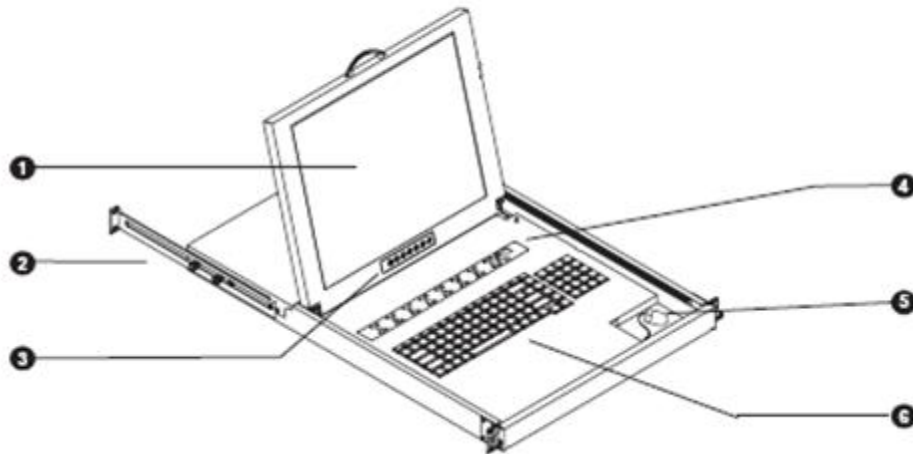

① SAMSUNG Class A TFT LCD Panel	② Adjustable rear mounting L-bracket
③ LCD membrane button	④ Membrane switch (KVM option)
⑤ Mini USB Option Mouse	⑥ 104 key notepad with full numerical pad

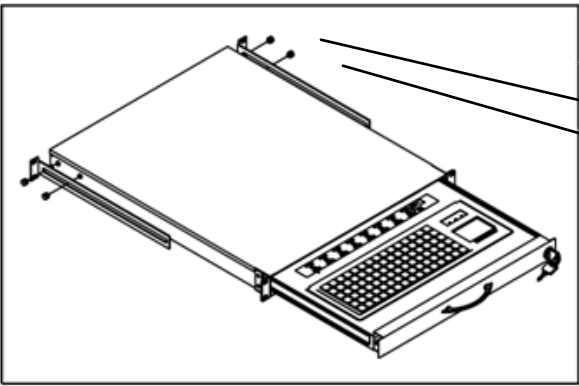
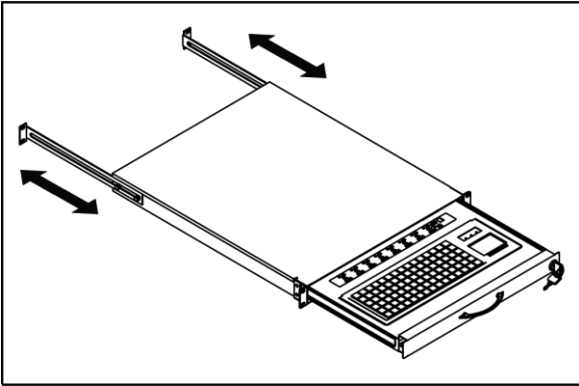
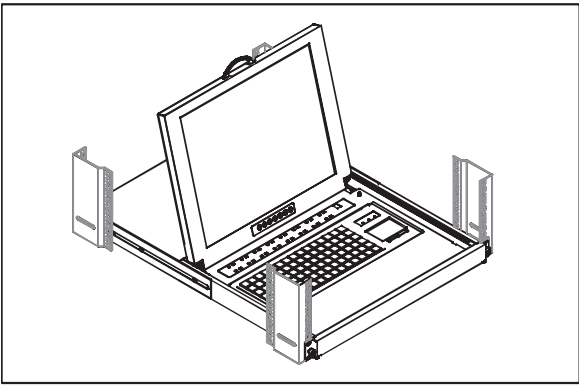

1.10 Installation

	<ul style="list-style-type: none">• Install each rear L-bracket using two fasteners shown in Figure 1.• Leave the fasteners slightly loose
	<ul style="list-style-type: none">• Measure the front and rear mounting depth of the rack.• Align each rear L-bracket to a suitable length and tighten the fasteners shown in Figure 2.
	<ul style="list-style-type: none">• Fix the LCD keyboard drawer into the rack. <p>* Hardware (screws and cage nuts) for fixing the mounting bracket to the rack is not provided.</p>

1.11 Connect to Server via USB Interface

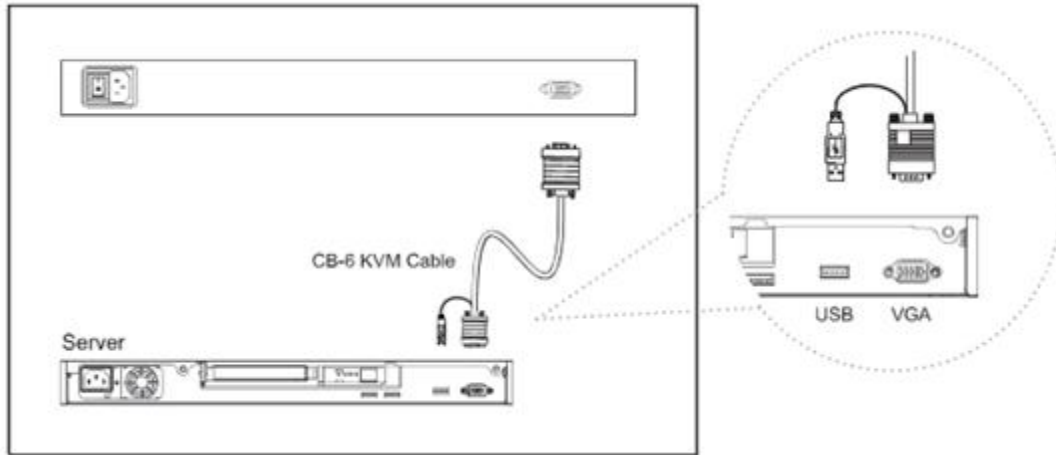

Figure 15: Example of connecting CD-6 2-in-1 USB KVM cable to server via USB Interface

1.12 Connect to KVM via USB Interface

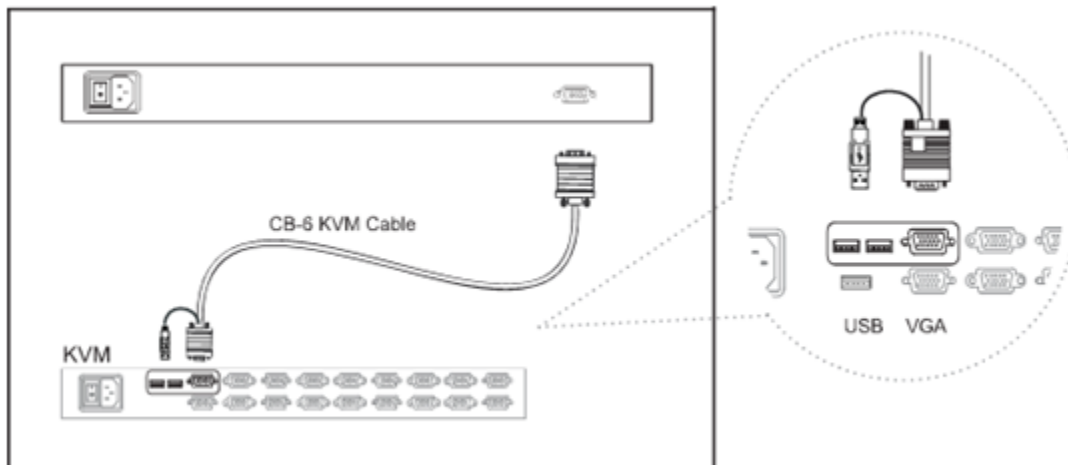

Figure 16: Example of connecting CD-6 2-in-1 USB KVM cable to KVM via USB Interface

*The above connection is only for the LCD keyboard without KVM switch built-in.
For the LCD keyboard drawer with KVM switch built-in, please refer to KVM switch manual.*

1.13 Connect to Server via PS/2 Interface

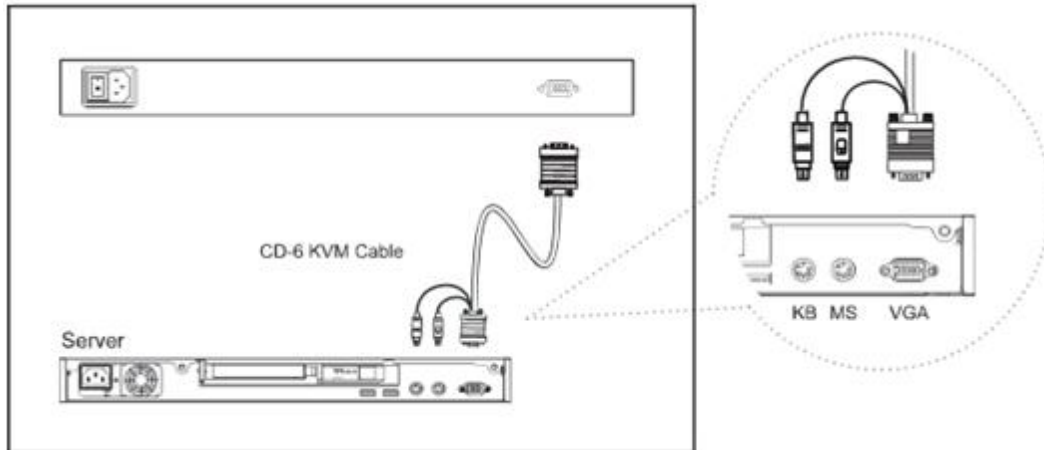

Figure 17: Example of connecting CD-6 3-in-1 PS/2 KVM cable to server via PS/2 Interface

1.14 Connect to KVM via PS/2 Interface

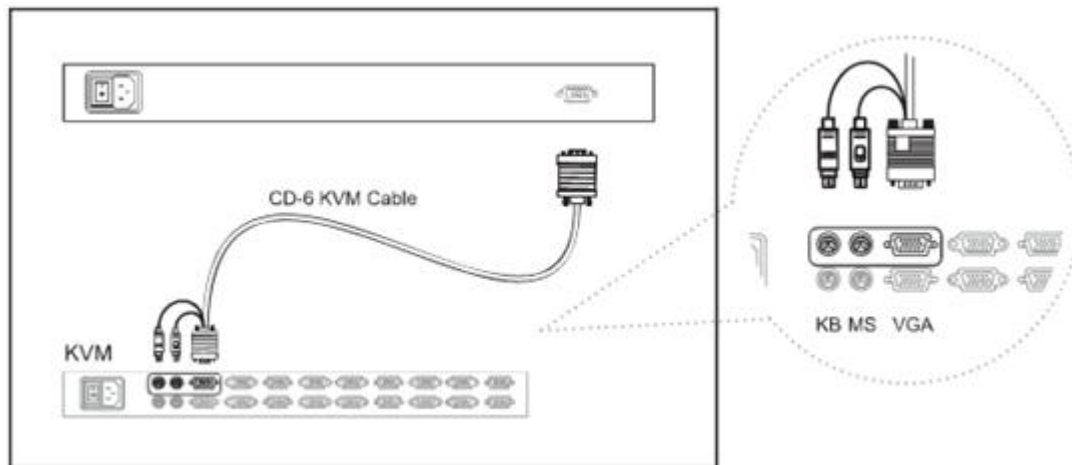
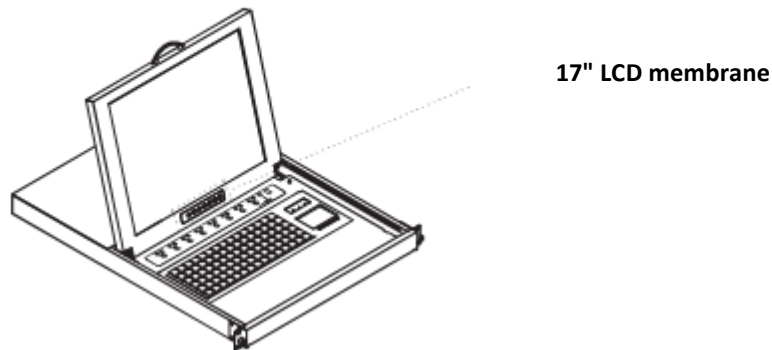









Figure 18: Example of connecting CD-6 3-in-1 PS/2 KVM cable to KVM via PS/2 Interface

*The above connection is only for the LCD keyboard without KVM switch built-in.
For the LCD keyboard drawer with KVM switch built-in, please refer to KVM switch manual.*

Section 2: Operations

2.1 On-screen Display Operation



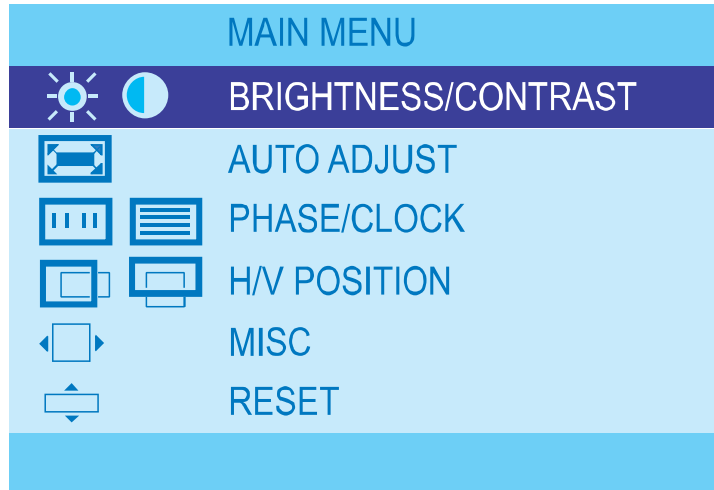

Membrane Switch	Function
	Power light
	Green = On
	Orange = Power saving
	Power on / off LCD
	Display the OSD menu
	Scrolls through menu options and adjusts the displayed control
	Exit the OSD screen Shortcut key to auto adjustment by pressing the button for 5 seconds or Toggle analog, digital & video connection (DVI-D and video options only)

2.2 On-screen Menu

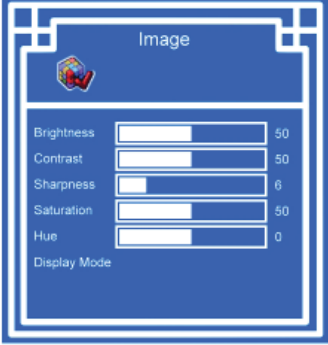
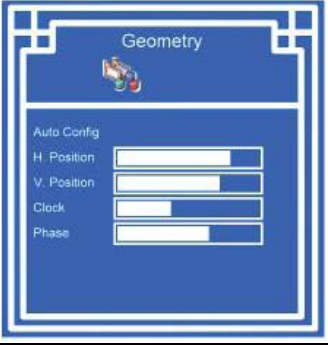

BRIGHTNESS / CONTRAST	
Brightness	Adjust background black level of the screen image.
Contrast	Adjust the difference between the image background (black level) and the foreground (white level)
AUTO ADJUST	
Auto Adjust	Fine tunes the video signal to eliminate waviness and distortion. A “Adjusting” message is displayed during the process
Auto Tune	Optimize phase, clock, position and size. An “Adjusting” message is displayed during the process
PHASE / CLOCK	
Phase / Clock	To enter into the Phase & Clock sub menu
H / V POSITION	
H / V Position	Align the screen image left or right and up or down
MISC	
Information	Display the current resolution, refresh rate and frequency information on the screen
OSD Timer	Set the time duration in seconds that the OSD is visible after the last button is pressed. The factory default is 10 seconds
Color	Select the screen color – 5500K, 65000K & 9500K, The factory default is 9500K
Language	Select the language in which the OSD menu is displayed: English, Chinese (中文), Japanese (日本語), German, French, Spanish, Italian.
RESET	
RESET	Restore the settings to factory default

2.3 On-Screen Menu for DVI, BNC, S-Video & RCA Input

1	Image		
	Brightness	Adjust background black level of the screen image	
	Contrast	Adjust the difference between the image background (black level) and the foreground (white level)	
	Sharpness	Adjust the image from weak to sharp	
	Saturation	Adjust the saturation of the image color	
	Hue	Adjust the screen hue value	
2	Geometry		
	Auto Config	Adjust automatically sizes, centers, and fine tunes the video signal to eliminate waviness and distortion. An "Adjusting" message is displayed during the process.	
	H. Position	Align the screen image left or right	
	V. Position	Align the screen image up or down	
	Clock	Adjust the clock value	
	Phase	Adjust the phase value	
3	Function		
	OSD Position	Adjust OSD menu horizontal and vertical position	
	OSD Zoom	Adjust the difference between the image background (black level) and the foreground (white level).	
	Color Temp	Select the screen color – 5500K, 6500K & 9500K. The factory default is 6500K.	
4	System		
	Language	Select the language in which the OSD menu is display. English, Chinese (中文), Japanese (日本語), German, French, Spanish, Italian	
	Time	Function is not supported	
	Power Off	Function is not supported	
	Reset	Reset all settings to factory default.	

Section 3: Specifications

Item	Description
Form Factor	1U rack mounting on slide-out rails
LCD Manufacturer	
Diagonal Size	17" TFT
Max. Resolution	1280 x 1024
Brightness (cd/m ²)	300
Color Support	16.2 Mil.
Contrast Ratio (typ.)	700:1
Viewing Angle (H/V)	150° x 135°
Display Area (mm)	337 x 270
Tr Response Time (ms)	2
VGA Signal Input	Analog RGB, 0.7Vp-p
Sync. Type	Separate H/V, Composite, SOG
Resolution	640 x 350, 70 Hz 720 x 400, 70 Hz 640 x 480, 60/ 72/ 75 Hz 800 x 600, 60/ 70/ 72/ 75 Hz 1024 x 768, 60/ 70/ 72/ 75 Hz 1152 x 864, 60/ 70/ 75 Hz 1280 x 1024, 60/ 70/ 75 Hz
Plug & Play DDC	EDID 1.3
Console Port (Combo)	3-in-1 DB-15 connector for VGA / keyboard /mouse Support USB & PS/2 servers or KVM Switches
Power Input	Auto-sensing 100 to 240VAC, 50 / 60Hz
Power Consumption	Max. 40 Watt, Standby 5 Watt
Compatibility	Multi-platform - Mix PCs, SUNs, IBMs, HPs & DELLs.
Regulation Approval	FCC, CE

Options

KVM Integration	Cat5 & DB-15 KVM with IP console and 2-console selection
Keyboard & mouse	Full size keyboard built-in touch-pad / trackball
Graphic Input	DVI-D, BNC, S-Video & RCA video input
DC Power	DC power input with 12V, 24V, 48V selection
Touchscreen	Resistive and capacitive type touchscreen selection

Environmental

Operation	0° to 50°C Degree
Storage	-5° to 65°C Degree
Relative Humidity	5~90%, non-condensing
Shock	10G acceleration (11ms duration)
Vibration	5~500Hz 1G RMS random vibration



3.1. Keyboard & Mouse

- Multiple keyboard language selections with touchpad
- Standard: WOM-01 Mini USB Option Mouse
- Optional: WOM-02 Wireless Option Mouse

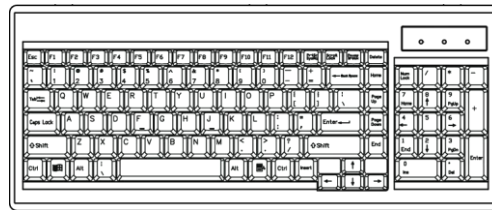
Supporting layouts

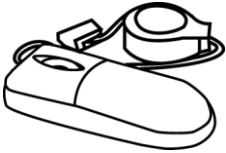

N N keyboard

	<p>WOM-01 Mini USB Option Mouse</p>
<p>Option:</p>	
	<p>WOM-02 Wireless USB Optical Mouse</p>

Section 4: Optional Specifications

4.1 KVM Options

Our KVM is designed to seamlessly integrate into the rear of our full range of LCD drawer solutions:

- For KVM operation, please refer to "Integrated LCD KVM Switch" user manual
- Option with high density Cat5 KVM with either 16 or 32 ports
- Option with cost efficient DB-15 KVM integration with either 8 or 16 ports
- Please ask your supplier for full KVM details

4.2 DVI-D Option

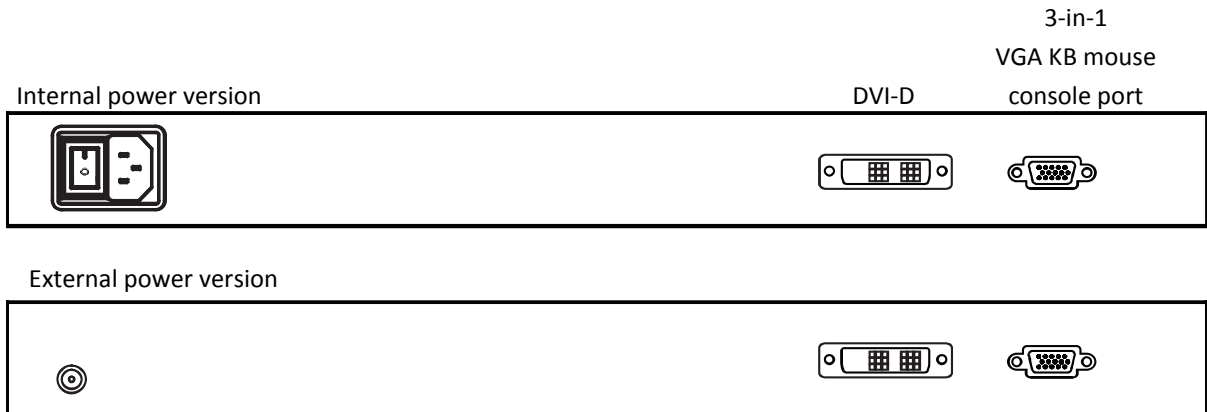

- Package includes a 6' DVI-D cable and a 6' 2-in-1 keyboard & mouse cable
- In DVD-D option, no VGA signal input is included

4.3 S-Video + RCA Input Option

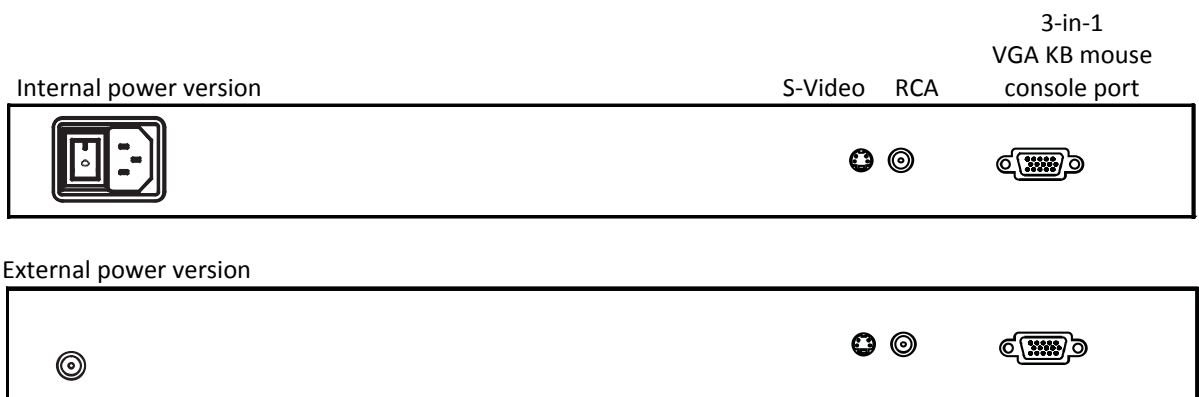

- Package includes an extra 6ft S-Video and 6ft RCA cables

4.4 S-Video + BNC Input Option

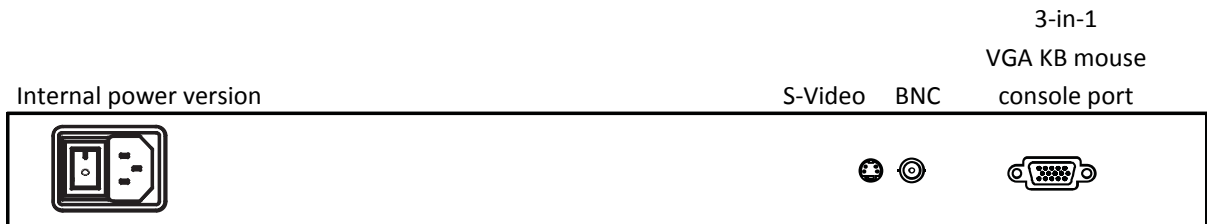

External power version

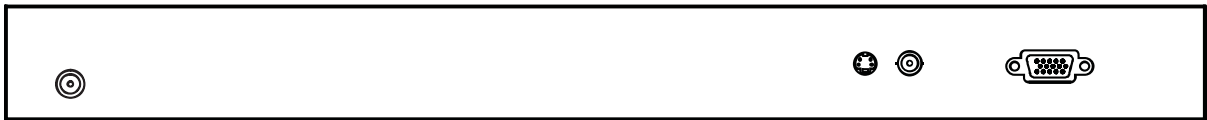

Remarks:

- Package includes an extra 6ft S-Video cable

4.5 DC Power Option

Model	12V	24V	48V
Input Rating			
Input Voltage	12 Volt	24 Volt	48 Volt
Input Range	9 ~ 18V	18 ~ 36V	36 ~ 75V
Input Current			
-No Load	50 mA	50 mA	50 mA
-Full Load	4950 mA	2450 mA	1220 mA
Output Rating			
Output Voltage	12 Volt	12 Volt	12 Volt
Output Current	4.16A	4.16A	4.16A
Efficiency	84%	85%	85%

- Package does not include power cord and AC power adapter
- With DC power option, the depth will be extended from 650mm (25.6") to 690mm (27.2")

Section 5: Troubleshooting

How do I adjust the resolution?

To change monitor resolution in Windows, click Start -> Control Panel -> Display. Select Settings tab to adjust the monitor resolution in Desktop Area. The available resolutions, “640x480”, “800x600”, “1024x768”, “1152x864”, 1280x1024”, are determined by the display card in your computer.

Is interface signal appeared on LCD normal when shutting down the computer?

In rare cases, interface may appear on the monitor. This may be caused by signal rate of VGA card and is considered normal. The image quality can be improved by adjusting the phase or pixel rate automatically or normally.

The membrane button power light is not ON

Press the Power ON/OFF on LCD membrane button to check if the monitor is in the ON mode. Check to see if the power cord is properly connected to the LCD keyboard drawer and power outlet.

Screen image is not centered or sized properly

Press the  button for two seconds to automatically adjust the image. Adjust the H-Position and V-Position settings via On-screen menu.

Is the LCD keyboard drawer hot-pluggable?

The LCD keyboard drawer is hot-pluggable, but components of connected devices, such as the servers and KVMs, may not be hot-pluggable. We suggest turning off the power to all devices before connecting them. Apply power to connected devices again only after the LCD keyboard receives power.

Section 6: Dimensions

Model	Product Dimension (W x D x H)	Package Dimension (W x D x H)	Net Weight	Gross Weight
RKVM-17-Mouse	442 x 650 x 44 mm 17.4 x 25.6 x 1.75 in	589 x 826 x 168 mm 23.2 x 32.5 x 6.6 in	17kg 37lb	23kg 51lb



Disclaimer

While every precaution has been taken in the preparation of this document, Avenview Inc. assumes no liability with respect to the operation or use of Avenview hardware, software or other products and documentation described herein, for any act or omission of Avenview concerning such products or this documentation, for any interruption of service, loss or interruption of business, loss of anticipatory profits, or for punitive, incidental or consequential damages in connection with the furnishing, performance, or use of the Avenview hardware, software, or other products and documentation provided herein.

Avenview Inc. reserves the right to make changes without further notice to a product or system described herein to improve reliability, function or design. With respect to Avenview products which this document relates, Avenview disclaims all express or implied warranties regarding such products, including but not limited to, the implied warranties of merchantability, fitness for a particular purpose, and non-infringement.