

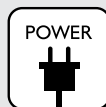

Control Your Video

VIDEO WALLS VIDEO PROCESSORS
VIDEO MATRIX SWITCHES
EXTENDERS SPLITTERS WIRELESS
CABLES & ACCESSORIES

8x4 Multi Input Presentation switcher with HDBaseT Support



Model #: SC-HBT-HDMA-8X4

© 2015 Avenview Inc. All rights reserved.

The contents of this document are provided in connection with Avenview Inc. ("Avenview") products. Avenview makes no representations or warranties with respect to the accuracy or completeness of the contents of this publication and reserves the right to make changes to specifications and product descriptions at any time without notice. No license, whether express, implied, or otherwise, to any intellectual property rights is granted by this publication. Except as set forth in Avenview Standard Terms and Conditions of Sale, Avenview assumes no liability whatsoever, and claims any express or implied warranty, relating to its products are strictly prohibited.

TABLE OF CONTENTS

SECTION 1: GETTING STARTED	3
1.1 IMPORTANT SAFEGUARDS	3
1.2 SAFETY INSTRUCTIONS	3
1.3 REGULATORY NOTICES FEDERAL COMMUNICATIONS COMMISSION (FCC)	4
2. INTRODUCTION	5
2.1 PACKAGE CONTENTS	6
2.2 BEFORE INSTALLATION	7
2.2 CABLE SPECIFICATIONS	7
3 APPLICATION DIAGRAM	8
4. PANEL DESCRIPTION	9
4.1. INPUT PANEL (FRONT)	9
4.2. INPUT PANEL (REAR)	10
4.3. REMOTE CONTROL	11
4.4 INSTALLATION (SC-HBT-HDMA-8X4)	11
4.5. IR CABLE DEFINITION	12
5. GENERAL TROUBLESHOOTING	13
SECTION 6: SPECIFICATIONS	14



SECTION I: GETTING STARTED

I.1 IMPORTANT SAFEGUARDS

Please read all of these instructions carefully before you use the device. Save this manual for future reference.

What the warranty does not cover

- Any product, on which the serial number has been defaced, modified or removed.
- Damage, deterioration or malfunction resulting from:
 - Accident, misuse, neglect, fire, water, lightning, or other acts of nature, unauthorized product modification, or failure to follow instructions supplied with the product.
 - Repair or attempted repair by anyone not authorized by us.
 - Any damage of the product due to shipment.
 - Removal or installation of the product.
 - External causes to the product, such as electric power fluctuation or failure.
 - Use of supplies or parts not meeting our specifications.
 - Normal wear and tear.
 - Any other causes which does not relate to a product defect.
- Removal, installation, and set-up service charges.

I.2 SAFETY INSTRUCTIONS



The SC-HBT-HDMA-8X4 Presentation Scaler has been tested for conformance to safety regulations and requirements, and has been certified for international use. However, like all electronic equipments, the SC-HBT-HDMA-8X4 should be used with care. Read the following safety instructions to protect yourself from possible injury and to minimize the risk of damage to the unit.

- ⚠ Do not dismantle the housing or modify the module.
- ⚠ Dismantling the housing or modifying the module may result in electrical shock or burn.
- ⚠ Refer all servicing to qualified service personnel.
- ⚠ Do not attempt to service this product yourself as opening or removing housing may expose you to dangerous voltage or other hazards
- ⚠ Keep the module away from liquids.
- ⚠ Spillage into the housing may result in fire, electrical shock, or equipment damage. If an object or liquid falls or spills on to the housing, unplug the module immediately.
- ⚠ Have the module checked by a qualified service engineer before using it again.
- ⚠ Do not use liquid or aerosol cleaners to clean this unit. Always unplug the power to the device before cleaning.



1.3 REGULATORY NOTICES FEDERAL COMMUNICATIONS COMMISSION (FCC)

This equipment has been tested and found to comply with Part 15 of the FCC rules. These limits are designed to provide reasonable protection against harmful interference in a residential installation. Any changes or modifications made to this equipment may void the user’s authority to operate this equipment.

Warning symbols	Description
	<p>ONLY USE THE PROVIDED POWER CABLE OR POWER ADAPTER SUPPLIED. DO NOT TAMPER WITH THE ELECTRICAL PARTS. THIS MAY RESULT IN ELECTRICAL SHOCK OR BURN.</p>
	<p>DO NOT TAMPER WITH THE UNIT. DOING SO WILL VOID THE WARRANTY AND CONTINUED USE OF THE PRODUCT.</p>
	<p>THE VIDEO BOARDS ARE VERY SENSITIVE TO STATIC. PLEASE ENSURE IF RACK MOUNTED OR INSTALLED ON A SURFACE, IT SHOULD BE IN A GROUNDED ENVIROMENT.</p>

	<p>⚠ WARNING</p> <p>Read & understand user guide before using this device.</p> <p>Failure to follow the proper installation instructions could result in damage to the product and preventing expected results.</p>
-------------------------------------------------------------------------------------	--------------------------------------------------------------------------------------------------------------------------------------------------------------------------------------------------------------------------------



2. INTRODUCTION

Avenview SC-HBT-HDMA-8X4 Presentation Scaler allows the user to switch and scale HDMI/HDBaseT/PC/Composite Video signals from any one of its eight inputs and simultaneously display it on any of its HDMI or HDBaseT outputs. The unit has an HDMI bypass output, allowing local monitoring of any of the HDMI or HDBaseT inputs, and features full 5play™ convergence for easy integration of compatible transmitters and receivers. Bonus feature to control via IR remote control, RS-232, IP/Telnet and WebGUI, and the system status Front panel LCD

Features

- HDMI, HDCP and DVI compliant;
 - Full 5Play™ convergence: Video, Audio, LAN serving, Power over Ethernet (PoE) and Control (IR & RS-232 bypass);
 - Supports High-definition Audio: LPCM 7.1CH, Dolby TrueHD, Dolby Digital Plus and DTS-HD Master Audio transmission (32-192kHz sample rate);
 - Supports distances of up to 100 meters over industry standard CAT5e/6/7 cables;
 - Supports scaling of any input signals to a wide range of HDTV and PC output resolutions up to 1080p and WUXGA (RB)
 - Digital to Analog and Analog to Digital Audio conversion (DAC/ADC);
 - Simultaneous video output of the selected source through the HDBaseT and HDMI outputs and audio output through the digital coaxial and analog L/R outputs;
 - Features four HDMI inputs with corresponding L/R audio inputs (3.5mm mini-jack), two HDBaseT CAT5e/6/7 inputs, PC (15-pin D-sub) with L/R audio (3.5mm mini-jack) and Composite Video and L/R audio (3 RCA);
 - Features two HDMI outputs, one HDBaseT CAT5e/6/7 output, one Digital Coaxial audio output and one L/R audio 3.5mm mini-jack output;
 - Supports switchable HDMI bypass allowing local monitoring of any of the HDMI or HDBaseT inputs;
- Supports Power over Ethernet (PoE) on the CAT5e/6/7 output to a compatible Receiver;
- Supports control via IR, Remote control, RS-232, Telnet, Web GUI and on-panel controls;
 - Supports HDBaseT LAN serving function to compatible Receivers;
 - Supports control via IR, Remote control, RS-232 and on-panel controls.

This model was tested with CAT6A (625MHz), 4-Pair, U/UTP-Unshielded cable, so if using Category cables of another type, results may vary.

NOTE:

- * The PoE function is designed for powering compatible Receiver units only.
- * The non-PoE Receivers has to be powered with a power supply.
- * Receivers (Rx) from different manufactures would not be compatible.



2.1 PACKAGE CONTENTS

Before you start the installation of the Extender, please check the package contents.

1	SC-HBT-HDMA-8X4	
2	IR Remote (Batteries included)	
3	IR Extender	
4	IR Receiver	
5	Power Adapter 24V/2.7A	
6	Power Cord	
7	User's Manual	



2.2 BEFORE INSTALLATION

- Put the product in a level and stable location. If the product falls, it may cause damage or malfunction to components within the casing.
- Do not place the product in temperatures under 0°C or over 50°C. High humidity may also cause the unit to malfunction.
- Use the DC power adapter with correct specifications supplied with the unit. If the improper power supply is used, this may result in malfunction of the unit and may cause fire.
- Do not twist or pull by force the ends of the HDMI/UTP cable. It can cause malfunction.

2.2 CABLE SPECIFICATIONS



We highly recommend achieving best results with our SC-HBT-HDMA-8X4 you acquire a high quality 26 or 24 AWG HDMI cable with the below specifications to maintain signal integrity and distances.

Features

- Length: 5m (16ft) to 15m (50ft)
- Bandwidth: 10.2 Gbps data transfer rate
- Supports Resolution: Up to 3840x2160 @ 24Hz and 4096x2160 @ 24Hz, 1080p @ 24Hz / 50/60Hz/3D
- Conductor gauge: 26 / 24 AWG
- Deep Color
- 3D Capable
- CEC
- Ethernet Channel
- Audio Return Channel
- Connector 1: HDMI (Type A) Male
- Connector 2: HDMI (Type A) Male



SC-HBT-HDMA-8X4

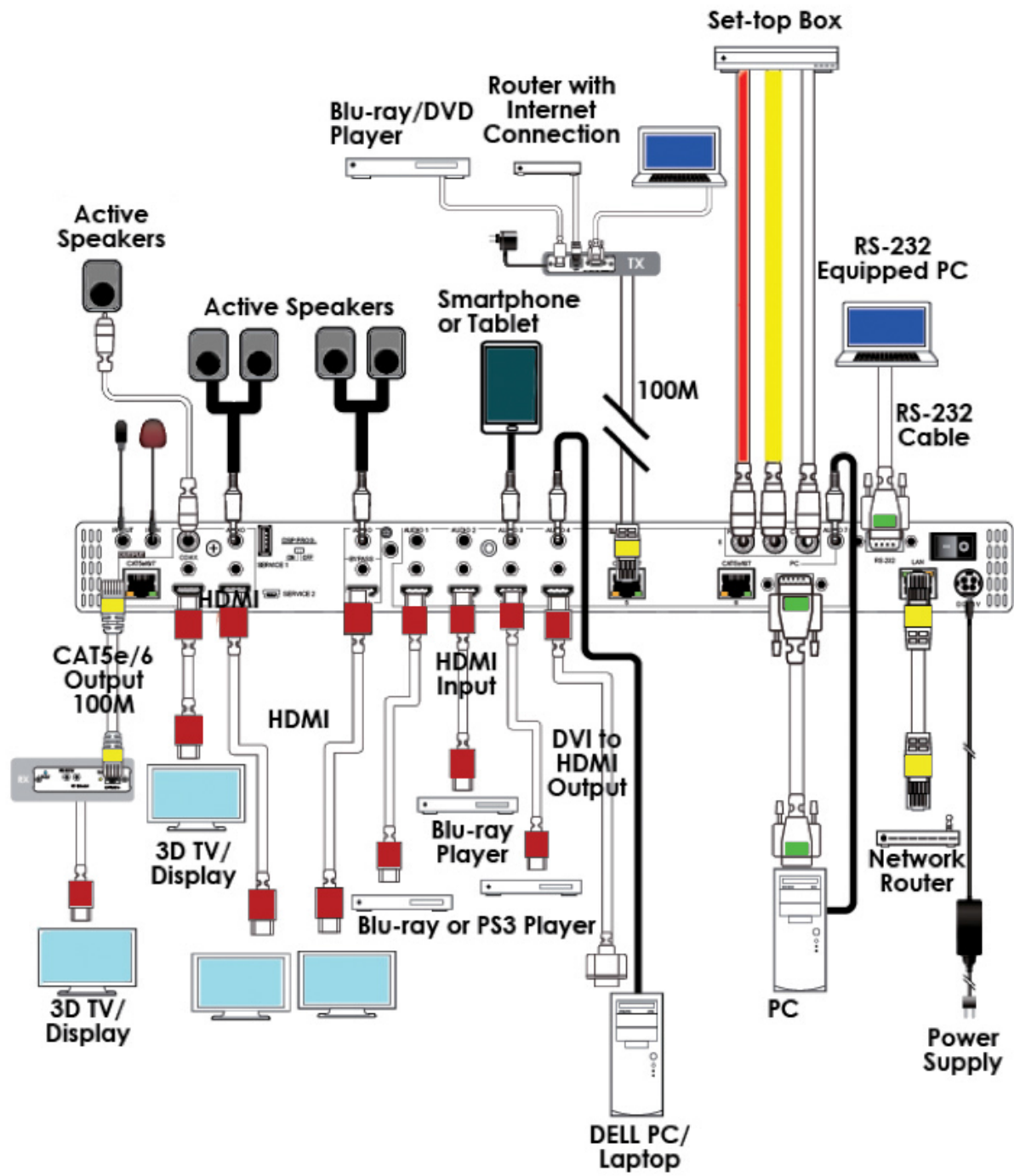

4. PANEL DESCRIPTION

4.1 INPUT PANEL (SC-HBT-HDMA-8X4) Front Panel

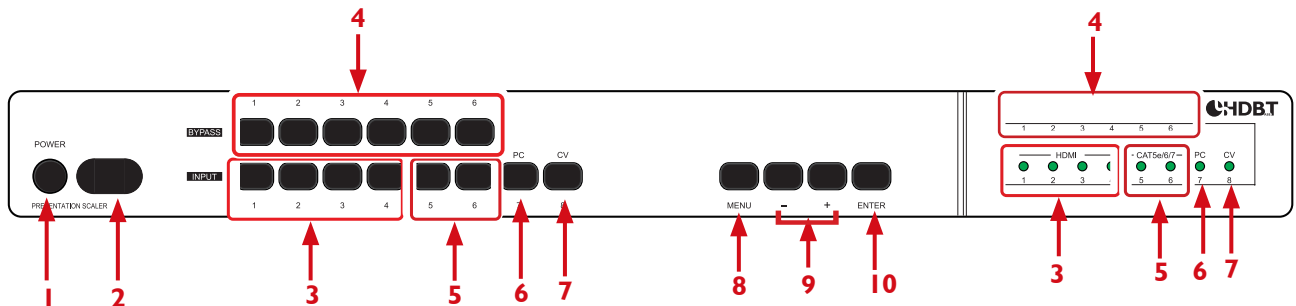

<p>1. POWER: Power ON the device and the LED will illuminate.</p>	<p>2. IR INTERFACE: Receives signal from the packaged included IR remote control.</p>
<p>3. INPUT HDMI 1-4 & LED: Select an input source signal from the 4 HDMI input sources to be display. LED illuminates accordingly.</p>	<p>4. BYPASS & LED: Select an input source signal from the 6 input sources to be display for BYPASS output port. LED illuminates accordingly</p>
<p>5. INPUT CAT5e/6/7 5-6 & LED: Select an input source signal from the 2 CAT5e/6/7 input sources.</p>	<p>6. INPUT PC & LED: Select PC input source signal to be display on PC output port.</p>
<p>7. INPUT CV & LED: Select CV input source signal to be display on CV output port.</p>	<p>8. MENU: 1st Press to enter into the menu and 2nd press to confirm the selection.</p>
<p>9. +/-: Press to move up/down under menu selection or under volume control to adjust audio volume up/down.</p>	<p>10. ENTER: Press this button to confirm menu selection</p>



4.2 INPUT PANEL (SC-HBT-HDMA-8X4) Rear Panel

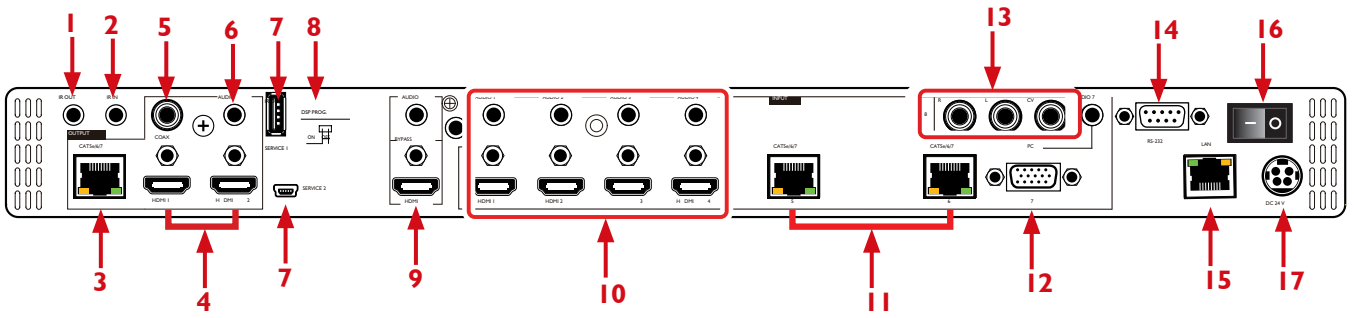

<p>1. IR OUT: Connect to the supplied IR Blaster cable for IR signal transmission. Place the IR Blaster in direct line-of-sight of the device to be controlled.</p>	<p>2. IR IN: Connect to the supplied IR Extender cable for IR signal reception. Remote should be in direct line-of-sight of the IR Extender.</p>
<p>3. OUTPUT CAT5e/6/7: Connect to the Receiver unit with a Single CAT5e/6/7 cable for transmission of all data signals.</p>	<p>4. OUTPUT HDMI: Connect to a HDMI equipped TV/monitor for display of the HDMI input source signal.</p>
<p>5. OUTPUT COAX: Connect to audio sound equipment such as speaker or amplifier for audio sound output.</p>	<p>6. OUTPUT AUDIO: Connect to peaker or amplifier for audio sound output.</p>
<p>7. SERVICE 1 & 2: Reserved for firmware update use only.</p>	<p>8. DISPLAY PROG. SWITCH: Reserved for firmware update use only. Default setting is on OFF.</p>
<p>9. BYPASS: Connect to a HDMI equipped TV/monitor with audio device for both video and audio output display.</p>	<p>10. INPUT HDMI 1-4 & AUDIO 1-4: Connect to HDMI/DVI source</p>
<p>11. INPUT CAT5e/6/7: Connect this port to CAT5e/6/7 Transmitter with CAT5e/6/7 cable to extend the signal up to 100m.</p>	<p>12. INPUT PC & AUDIO: Connect this port to PC/Laptop with audio signal for input signal selecting.</p>
<p>13. INPUT CV: Connect this port to source such as video player or Set-Top-Box for input signal selecting.</p>	<p>14. RS-232: Connect from PC/Laptop for RS-232 command sending to control the device.</p>
<p>15. LAN: Connect from PC/Laptop with active internet service for Web GUI control with RJ-45 terminated cable.</p>	<p>16. POWER TOGGLE: Powers the device On and OFF</p>
<p>17. DC 24V: Connect the adaptor with power cord included in the package and connect to AC wall outlet for power supply.</p>	



4.3 REMOTE CONTROL

1 POWER:

Press this button to switch the device ON or to put the device into Standby mode.

2 MUTE:

Press this button to mute output audio sound.

3 INPUT:

Press these buttons one time each to select input source for outputs display.

4 MENU:

Press this button to enter into the On-Screen Menu.

5 EXIT:

Press this button to exit menu selection.

6 ▲▼◀▶ & OK:

Press OK to confirm the selection or use the directional buttons to navigate the On-Screen-Menu.

7 ADJUST:

Press this button when output image is not fitting the display's screen perfectly. The device will auto adjust the image to full screen.

8 RESET:

Press this button to set the device back into the factory default setting.

9 BYPASS:

Press these buttons to select an input source for Bypass output port to display.

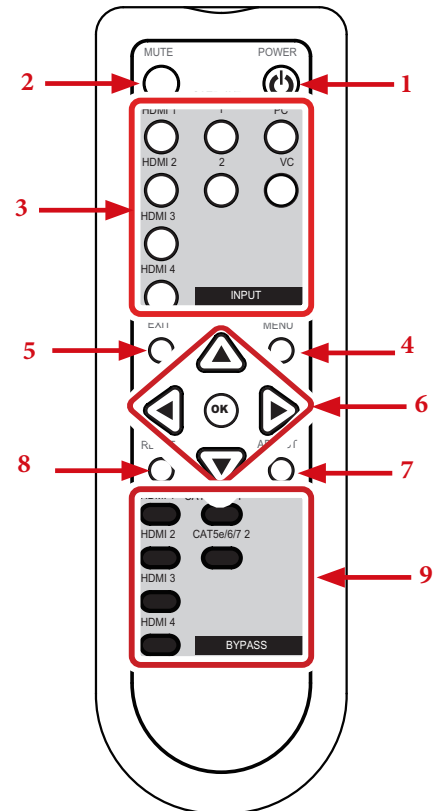

4.4 INSTALLATION (SC-HBT-HDMA-8X4)

To setup Avenview SC-HBT-HDMA-8X4 please follow these steps for connecting to a device:

1. Power off sources such as using Laptop/PC DVD player at Podium or where installed.
2. Connect up to 8 video Sources to the Multi INPUT- up to with Full HD, 3D and 4k x 2k support
3. Connect CAT 5/6 OUT to a compatible HBT-C6POEWP-R (Rx) CAT 5/6 IN and HDMI cable to HDMI or VGA Displays
4. Plug in 24V/2.7DC power adapter to the screw terminal HBT-C6POEWP-S- Green LED illuminate
5. Power on all 8 Sources and HDMI Display
7. When the Input is connected and turned on the corresponding LED will light on the LINK LED when signal is detected and transmitting.



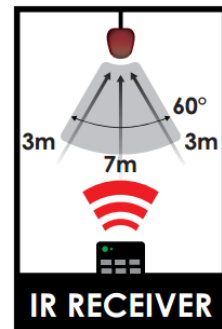
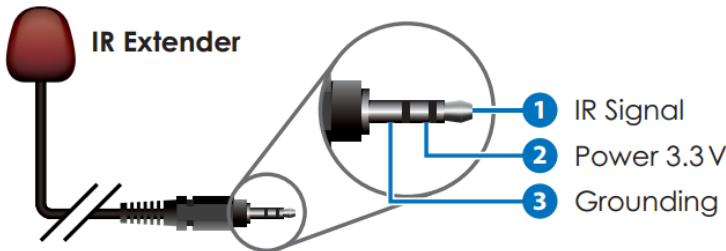
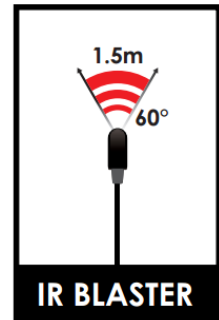
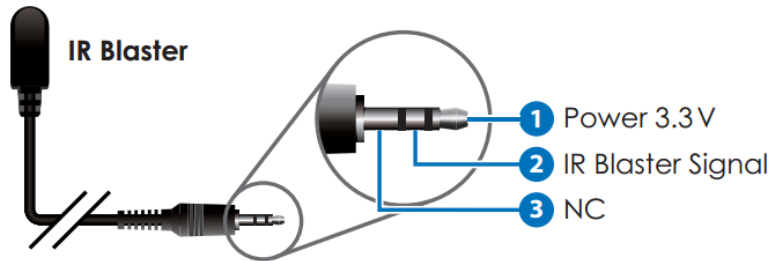

IR Sockets

IR BLASTER: plug in the IR blaster to the HBT-C6POE-R to emit all IR command signals received from the IR Extender plugged into the Rx (Monitor Side) to control the devices corresponding to the IR signals.
Example: Set Top Box or DVD player (The Source).

IR EXTENDER: plug in the IR Extender into the (RX) Receiver (Monitor Side) to receive all IR command signals from the IR remote controls of the corresponding source.
Example: Set Top Box or DVD player (IR Remote Control).

WARNING

NOTE: Incorrect placement of IR Blaster and IR Extender into the extender may result in the failure of the IR extenders.

Please check carefully before plugging in the IR extender to the respective IR sockets.

It is clearly marked and IR IN: IR EXTENDER /IR OUT: IR BLASTER

WARRANTY WILL NOT COVER THE DAMAGE.



5. GENERAL TROUBLESHOOTING

PROBLEM	POSSIBLE SOLUTION
NO IMAGE	<ul style="list-style-type: none"> • Check if connection to the source and the display are correct. • Ensure that display device supports 480p, 720p and 1080p 4K@30 resolution • Terminated to 568B standard with Shielded Ends Recommended • High Quality CAT5/6/7 Cable helps signal transmission • Please use the supplied power supply-DC 24V 2.7A • Check LED Link light see (Section 3 Panel Description) • Check LED Sync light see (Section 3 Panel Description)
EDID ISSUE	<ul style="list-style-type: none"> • EDID MODE-: The unit will detect the 1st CAT5e/6/7 output's EDID. When obtained a (4K2K) Ultra HD 3840x2160 EDID the signal is transmitted. • If the 1st CAT5e/6/7 output is without a Ultra HD 3840x2160 EDID the unit will detect all output's EDID and Transmit the signal that all outputs can accept.
Set-Top Box No Picture	<ul style="list-style-type: none"> • HDBaseT and HDMI 1.3 standards support CLOCK STRETCHING for i2c buss protocol • Example set top boxes like Scientific Atlantic results no picture. This can be resolved by swapping out the box for a newer version that supports HDMI 1.3 not HDMI 1.2
NO Infrared Communication	<ul style="list-style-type: none"> • Ensure the UTP cable is run within the wall away from EMI and High Voltage power Lines. • Please check manual of device to ensure proper placement of IR Blaster on IR EYE. • Some LED /Plasma TV have EMI interference with the IR Extender, please place the IR Rx 3-6" away from Screen
Recommended TEST	
End-to-End Testing	HDBaseT system, a final end-to-end test of all the A/V components should take place. These tests include checking the HDMI stream at the far end (sink end), the clock rate, frame compare, video pattern, audio, EDID and HDCP with Quantum 780 (recommended)
Passive Monitoring:	Passive monitoring enables an integrator to view the HDCP transactions, EDID exchange, as well as the connection events between the actual devices in the network.

NOTE

Additional info on Guidelines to Test & Troubleshoot HDBaseT Systems

Can be retrieved from our website under the category Downloads for this product SC-HBT-HDMA-8X4



SECTION 6: SPECIFICATIONS

ITEM	DESCRIPTION
UNITS	SC-HBT-HDMA-8X4
UNIT DESCRIPTION	8x4 HDBaseT Presentation Switcher
HDMI COMPLIANCE	YES HDBaseT
HDCP	Yes
VIDEO BANDWIDTH	[10.2Gbps]
SUPPORTED RESOLUTIONS	480i-1080p@50/60,1080p@24 VGA-WUXGA(RB)
CAT5/6/7 CABLE	4K2K: (3840X2160@30Hz) ~ 75meter (250feet) (CAT6e) / 100meter (330feet) (CAT6a) FULL HD: (1080p) ~ 100meter (330feet) (CAT6e) / 110meter (360feet) (CAT6a)
AUDIO SUPPORT	LPCM 2CH, Dolby Digital 2~5.1CH/ DTS
ESD PROTECTION	Human body model — ±8kV (air-gap discharge) & ±4kV (contact discharge)
INPUT	4 x HDMI 4 x L/R 2 x CAT5e/6/7 1 x PC + L/R 1 x CV+L/R 2 x USB (Service only) 1 x LAN 1 x RS-232 1 x IR
OUTPUT	1 x L/R/1 x Coaxial 1 x CAT5e/6/7 1 x HDMI Bypass 2 x HDMI
HDMI CONNECTOR	Type A (19 pin female)
LED	GREEN/YELLOW LED
IR FREQUENCY	30~50kHz
DIMENSIONS (L X W X H)	438mm (W) x 275mm (D) x 44mm (H)
WEIGHT	7.5 lbs 3410g
POWER SUPPLY	24V / 2.7A DC (US/EU standards, CE/FCC/UL certified)
POWER CONSUMPTION	85 Watt
<i>ENVIRONMENTAL</i>	
OPERATING TEMPERATURE	32° ~ 104°F (0° to 40°C)
STORAGE TEMPERATURE	-4° ~ 140°F (-20° ~ 60°C)
RELATIVE HUMIDITY	20~90% RH (non-condensing)



NOTICE

1. *All HDMI over UTP transmission distances are measured using Belden CAT6A (625MHz), 4-Pair, U/UTP-Unshielded, Riser-CMR, Premise Horizontal Cable, 23 AWG Solid Bare Copper Conductors, Polyolefin Insulation, Patented Double-H spline, Ripcord, PVC Jacket using Quantum 980 signal HDMI Video Generator Module Video Pattern Testing.*
2. *The transmission length is largely affected by the type of category cables, also the type of HDMI sources, and the type of HDMI display. The testing result shows solid UTP cables (usually in the form of 300m or 1000ft bulk cable) can transmit a lot longer signals than stranded UTP cables (usually in the form of patch cords). Shielded STP connectors are better suit than unshielded UTP connectors. A solid UTP CAT5e cable shows longer transmission length than stranded STP CAT6 cable. For long extension users, solid cables are your only choice.*
3. *EIA/TIA-568-B termination (T568B) for category cables is recommended for better performance.*
4. *To reduce the interference among the unshielded twisted pairs of wires in category cable, you can use shielded STP cables with shielded connector to improve EMI problems, which occurs in long transmission.*
5. *Because the quality of the category cables has the major effects in how long transmission distance will be made and how good is the received display, the actual transmission length is subject to your category cables. For resolution greater than 1080i or 1280x1024, a solid CAT6 cable is the only viable choice.*





Control Your Video

TECHNICAL SUPPORT

CONTACT US



Phone: 1 (866) 508 0269



Email: support@avenview.com



USA Head Office Avenview Corp. 275 Woodward Avenue Kenmore, NY 14217

Avenview Canada

151 Esna Park Drive, Unit 11-12
Markham, ON L3R 3B1
Phone: +1 905 907 0525
Email: info@avenview.com
Sales: sales@avenview.com

Avenview USA

1100 Military Road
Kenmore, NY 14217
Phone: +1 716 218 4100 x223
Fax: +1 866 387 8764 Email:
info@avenview.com

Avenview Europe

Phone: +31 085 2100 613
Email: info@avenview.eu

Avenview Asia

Email: wenxi@avenview.com.hk
Sales: sales@avenview.com.hk

Disclaimer

While every precaution has been taken in the preparation of this document, Avenview Inc. assumes no liability with respect to the operation or use of Avenview hardware, software or other products and documentation described herein, for any act or omission of Avenview concerning such products or this documentation, for any interruption of service, loss or interruption of business, loss of anticipatory profits, or for punitive, incidental or consequential damages in connection with the furnishing, performance, or use of the Avenview hardware, software, or other products and documentation provided herein.

Avenview Inc. reserves the right to make changes without further notice to a product or system described herein to improve reliability, function or design. With respect to Avenview products which this document relates, Avenview disclaims all express or implied warranties regarding such products, including but not limited to, the implied warranties of merchantability, fitness for a particular purpose, and non-infringement.