

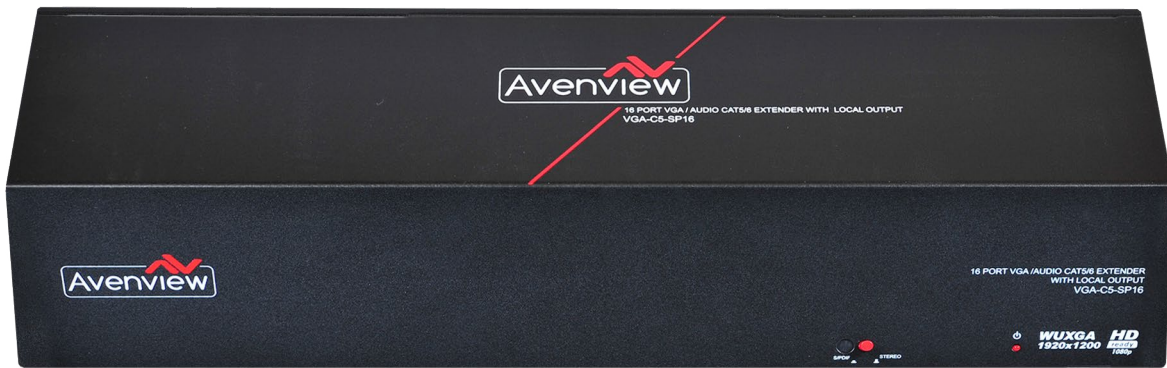

AV Connectivity, Distribution And Beyond...

VIDEO WALLS VIDEO PROCESSORS
VIDEO MATRIX SWITCHES
EXTENDERS SPLITTERS WIRELESS
CABLES & ACCESSORIES

16 Port VGA / Audio Extender / Splitter With Local Output with SPDIF



Model #: VGA-C5SP-16

© 2013 Avenview Inc. All rights reserved.

The contents of this document are provided in connection with Avenview Inc. ("Avenview") products. Avenview makes no representations or warranties with respect to the accuracy or completeness of the contents of this publication and reserves the right to make changes to specifications and product descriptions at any time without notice. No license, whether express, implied, or otherwise, to any intellectual property rights is granted by this publication. Except as set forth in Avenview Standard Terms and Conditions of Sale, Avenview assumes no liability whatsoever, and disclaims any express or implied warranty, relating to its products of Avenview Inc. is strictly prohibited.

Product Application & Market Sectors



Corporate



House Of Worship



Military



Residential



Education



Industrial



Medical



Aviation



TABLE OF CONTENTS

1.	GETTING STARTED	1
1.1	IMPORTANT SAFEGUARDS.....	1
1.2	SAFETY INSTRUCTIONS	1
1.3	REGULATORY NOTICES FEDERAL COMMUNICATIONS COMMISSION (FCC)	2
2.	INTRODUCTION	3
2.1	PACKAGE CONTENTS	3
2.2	BEFORE INSTALLATION.....	4
2.3	PANEL DESCRIPTION.....	5
2.3.1	INPUT PANEL (Receiver, VGA-C5SP-16) Front Panel	5
2.3.2	OUTPUT PANEL (Receiver, VGA-C5SP-16) Rear panel	5
4.	INSTALLATION.....	6
5.	GENERAL TROUBLESHOOTING.....	6
6.	SPECIFICATIONS.....	7
	PERFORMANCE GUIDE FOR HDMI OVER CATEGORY CABLE TRANSMISSION.....	8



SECTION I: GETTING STARTED

I.1 IMPORTANT SAFEGUARDS

Please read all of these instructions carefully before you use the device. Save this manual for future reference.

What the warranty does not cover

- Any product, on which the serial number has been defaced, modified or removed.
- Damage, deterioration or malfunction resulting from:
- Accident, misuse, neglect, fire, water, lightning, or other acts of nature, unauthorized product modification, or failure to follow instructions supplied with the product.
- Repair or attempted repair by anyone not authorized by us.
- Any damage of the product due to shipment.
- Removal or installation of the product.
- Causes external to the product, such as electric power fluctuation or failure.
- Use of supplies or parts not meeting our specifications.
- Normal wear and tear.
- Any other causes which does not relate to a product defect.
- Removal, installation, and set-up service charges.

I.2 SAFETY INSTRUCTIONS

The Avenview VGA-C5-SP-4, VGA-C5-SP-8, VGA-C5-SP-16, VGA & Audio Extender/Splitter, Single CAT5 have been tested for conformance to safety regulations and requirements, and has been certified for international use. However, like all electronic equipment's, the VGA-C5-SP-XX should be used with care. Read the following safety instructions to protect yourself from possible injury and to minimize the risk of damage to the unit.



- ⚠ Do not dismantle the housing or modify the module.
- ⚠ Dismantling the housing or modifying the module may result in electrical shock or burn.
- ⚠ Refer all servicing to qualified service personnel.
- ⚠ Do not attempt to service this product yourself as opening or removing housing may expose you to dangerous voltage or other hazards
- ⚠ Keep the module away from liquids.
- ⚠ Spillage into the housing may result in fire, electrical shock, or equipment damage. If an object or liquid falls or spills on to the housing, unplug the module immediately.
- ⚠ Have the module checked by a qualified service engineer before using it again.
- ⚠ Do not use liquid or aerosol cleaners to clean this unit. Always unplug the power to the device before cleaning.



1.3 REGULATORY NOTICES FEDERAL COMMUNICATIONS COMMISSION (FCC)

This equipment has been tested and found to comply with Part 15 of the FCC rules. These limits are designed to provide reasonable protection against harmful interference in a residential installation.

Any changes or modifications made to this equipment may void the user's authority to operate this equipment.

Warning symbols	Description
	<p>ONLY USE THE PROVIDED POWER CABLE OR POWER ADAPTER SUPPLIED. DO NOT TAMPER WITH THE ELECTRICAL PARTS. THIS MAY RESULT IN ELECTRICAL SHOCK OR BURN.</p>
	<p>DO NOT TAMPER WITH THE UNIT. DOING SO WILL VOID THE WARRANTY AND CONTINUED USE OF THE PRODUCT.</p>
	<p>THE VIDEO BOARDS ARE VERY SENSITIVE TO STATIC. PLEASE ENSURE IF RACK MOUNTED OR INSTALLED ON A SURFACE, IT SHOULD BE IN A GROUNDED ENVIROMENT.</p>

	<p>⚠ WARNING</p>
	<p>Read & understand user guide before using this device.</p> <p>Failure to follow the proper installation instructions could result in damage to the product and preventing expected results.</p>







2. INTRODUCTION

The Avenview VGA-C5-SP-4, VGA-C5-SP-8, VGA-C5-SP-16, VGA and Audio over CAT5 Transmitter / Splitter provides the most flexible solution by which the high resolution Video and high quality stereo Audio can be transmitted to different locations over super long distances. Built with 2 VGA and digital/analog audio loop outs, local A/V receivers can provide extra video and audio fan-outs through typical VGA, SPDIF, and analog audio cables. The high bandwidth VGA can be transmitted up to 65 meters (210 feet) on the local ports. The VGA-C5-SP-4, VGA-C5-SP-8, VGA-C5-SP-16 also extends VGA and stereo audio source up to 330 meters (1000 feet) through cost effective CAT-5 LAN cables. Accompanying the receivers of VGA-C5A-R VGA CAT5 extender series equipped with the equalization, gain control and de-skew functions, the video and audio quality can be further assured and make the quality of overall transmission superior than the other VGA splitters on the market.

- Supports up to WUXGA (1920x1200@60) to 300m (1,000ft)
- Supports Analog Stereo Audio and S/PDIF Digital Audio
- Adjustable equalization and gain control on Receiver unit
- De-skew compensation available for RGB delay control

2.1 PACKAGE CONTENTS

Before you start the installation of the converter, please check the package contents.

1	VGA-C5SP-16	X 1	
2	Power Adapter (+5V 4A DC)	X 1	
3	User's Manual	X 1	
4	Rack Mount Kit	X 1	



2.2 BEFORE INSTALLATION

- Put the product in an even and stable location. If the product falls down or drops, it may cause an injury or malfunction.
- Don't place the product in too high temperature (over 50°C), too low temperature (under 0°C) or high humidity.
- Use the DC power adapter with correct specifications. If inappropriate power supply is used then it may cause a fire.
- Do not twist or pull by force ends of the UTP cable. It can cause malfunction.

VGA-C5-SP16

720p = 330m (1083 feet) **CAT5E**
 UXGA(1600X1200@60) = 300m (1000 feet) **CAT6**
 1080p60(WUXGA1920X1200@60) = 300m (1000 feet) **CAT5E**
 1080p60(WUXGA1920X1200@60) = 310m (1015 feet) **CAT6**

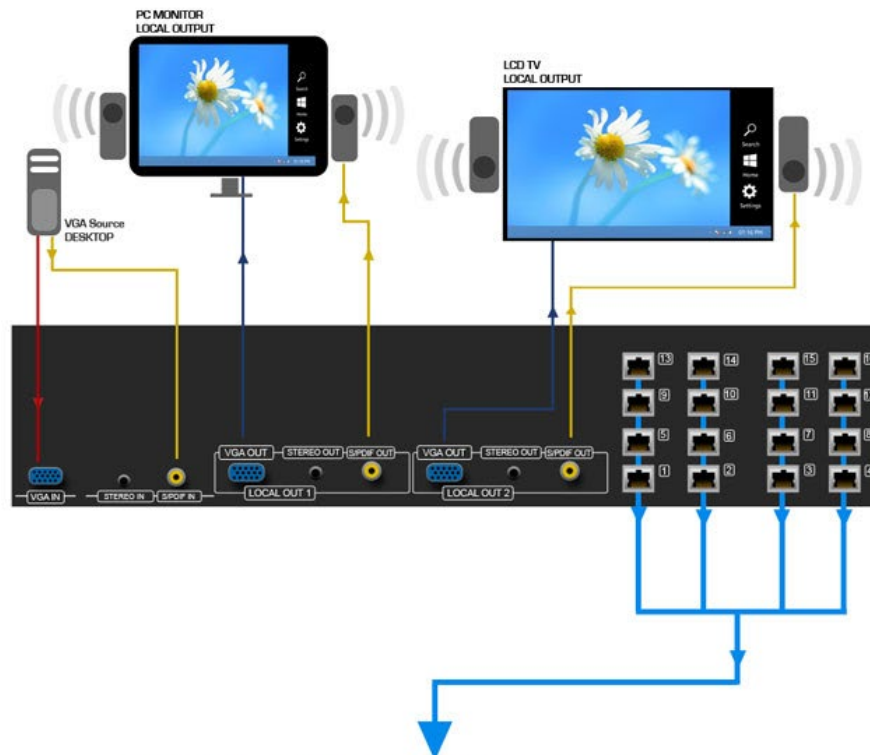

CAT5E -X16 OUT VIDEO & AUDIO TO -X16 VGA-C5A-R



CABLE INDEX

■	Output
■	Input / Source
■	S/PDIF
■	Audio
■	CAT-5 / CAT-6



2.3 PANEL DESCRIPTION

2.3.1 INPUT PANEL (Receiver, VGA-C5SP-I6) Front Panel



1. Audio Select Button Down SPDIF/ UP Stereo

2. Power LED light

2.3.2 OUTPUT PANEL (Receiver, VGA-C5SP-I6) Rear panel

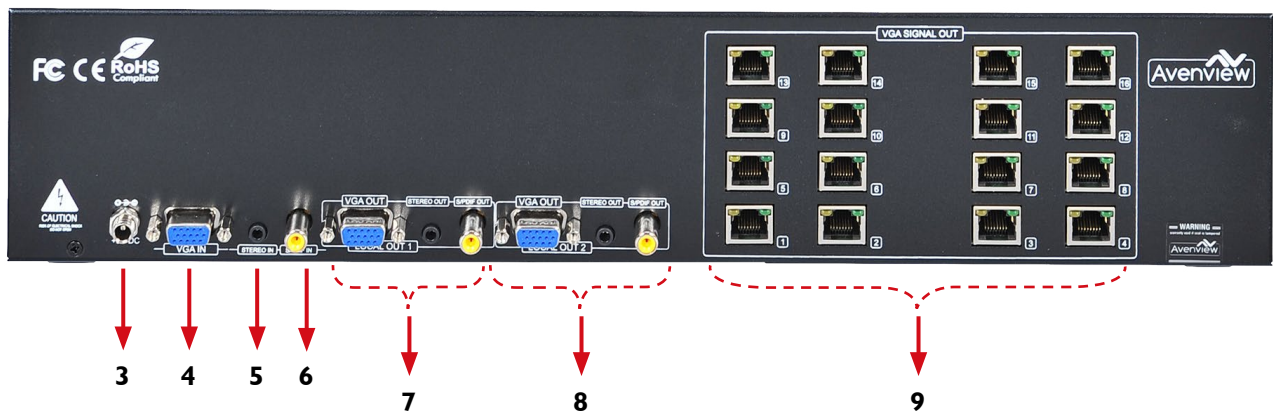

3. Power Connector

4. VGA Input Female Connector

5. Stereo Audio Input (3.5mm jack)

6. S/PDIF Input (RCA jack)

7. Local Video and Audio Output
(Analog Audio Out 3.5mm & Digital Audio Out RCA)

8. Local Video and Audio Output
(Analog Audio Out 3.5mm & Digital Audio Out RCA)

9. 16 Bank of RJ45 Outputs to Rx VGA-C5A-R



4. INSTALLATION

1. Connect VGA and audio source to Transmitter (VGA-C5-SPI6)
2. Connect VGA display and speakers to Receiver (VGA-C5A-R)
3. Connect CAT5/CAT6 cable between Transmitter (VGA-C5-SPI6) and Receiver (VGA-C5A-R)
4. Ensure that cables are tightly connected
5. Plug in 5V 2ADC power adapter to the power jack of the Receiver VGA-C5A-R.
6. Plug in 5V 4ADC power adapter to the power jack of the Transmitter VGA-C5-SPI6.

5. GENERAL TROUBLESHOOTING

PROBLEM	POSSIBLE SOLUTION
NO IMAGE	<ul style="list-style-type: none">• Check if connection to the source and the display are correct.• Ensure that display device supports the resolution that is being output.
COMMON VIDEO PROBLEMS	
GHOSTING	<ul style="list-style-type: none">• This product supports up to WUXGA (1920x1200) resolution.• Check the VGA and CAT5 connection• If outputting from a PC. Check the maximum resolution range of the graphics card.
NOISE	<ul style="list-style-type: none">• Adjust Skew + - (#6,7)for Horizontal Synchronization
COLOR MISMATCH	<ul style="list-style-type: none">• Adjust the Gain(#4) or Color Channels RGB(#5)
SMEARING OF VIDEO	<ul style="list-style-type: none">• Adjust the EQ (#3 see Section 3)

Gain rotary controls - are designed for gain control.

EQ rotary controls - are designed for equalizing the wave form of the receiving video signal.

RGB Delay Control [de-skew] - offers the flexible functionality to allow skew compensation among VGA RGB signals due to long transmission or thru low quality cable.

NOTE: It is suggested to begin with adjusting the rotary control of EQ to get the input video displayed first, and then the gain according to the video you see on the screen.

When adjusting the rotary switch first choose R, G or B color channel, second use the push buttons to increase or decrease the delay in the corresponding color channel. There are totally 31 steps, each step with 2nanoseconds (ns) difference, for adjusting the delay between each color individually. Then the graphics quality can be further assured.



6. SPECIFICATIONS

ITEM	DESCRIPTION		
	VGA-C5-SP-4	VGA-C5-SP-8	VGA-C5-SP-16
UNITS	VGA-C5-SP-4	VGA-C5-SP-8	VGA-C5-SP-16
UNIT DESCRIPTION	4 Port VGA Extender Splitter	8 Port VGA Extender Splitter	16 Port VGA Extender Splitter
VIDEO BANDWIDTH	350MHz		
VIDEO SUPPORT	VESA		
SUPPORTED RESOLUTIONS	Up to WUXGA (1920 x1200)	Up to 1280x1024	
RESOLUTION AND DISTANCE	WUXGA 1920x 1200 at 300 meters (1000 feet)	1280x1024 at 300 meters (1000 feet)	
AUDIO SUPPORT	Stereo		
EQUALIZATION	Continuous Analog Control		
INPUT VIDEO SIGNAL	1.2 Volts (peak-to-peak)		
ESD PROTECTION	- Human body model — $\pm 15\text{kV}$ (air-gap discharge) & $\pm 8\text{kV}$ (contact discharge) - Core chipset — $\pm 8\text{kV}$		
INPUT	1 x VGA 1 x RCA 1 x 3.5mm Audio		
OUTPUT	2 x VGA 2 x RCA 2 x 3.5mm 4 x RJ45	2 x VGA 2 x RCA 2 x 3.5mm 8 x RJ45	2 x VGA 2 x RCA 2 x 3.5mm 16 x RJ45
VGA CONNECTOR	HD-15 (15 pin D-sub Female)		
RJ45 CONNECTOR	WE/SS 8P8C with 2 LED indicators		
3.5MM AUDIO CONNECTOR	Earphone jack for Analog Stereo Audio		
RCA CONNECTOR	S/PDIF Digital Audio		
DIMENSIONS (L X W X H)	16" x 3.8" x 1.7"	16" x 3.8" x 3.5"	
POWER SUPPLY	5V 4A DC		
POWER CONSUMPTION	10 Watt (max)	15 Watt (max)	25 Watt (max)









Environmental

OPERATING TEMPERATURE	32° ~ 104°F (0° to 40°C)
STORAGE TEMPERATURE	-4° ~ 140°F (-20° ~ 60°C)
RELATIVE HUMIDITY	20~90% RH (no condensation)



Notice

1. All VGA over CAT5 transmission distances are measured using Belden 1583A CAT5e 125MHz UTP cable and ASTRODESIGN Video Signal Generator VG-859C.
3. The transmission length is largely affected by the type of category cables, the type of VGA sources, and the type of VGA display. The testing result shows solid UTP cables (usually in the form of 300m or 1000ft bulk cable) can transmit a lot longer signals than stranded UTP cables (usually in the form of patch cords). Shielded STP cables are better suit than unshielded UTP cables. A solid UTP CAT5e cable shows longer transmission length than stranded STP CAT6 cable. For long extension users, solid cables are your only choice.
4. EIA/TIA-568-B termination (T568B) for category cables is recommended for better performance.
5. To reduce the interference among the unshielded twisted pairs of wires in category cable, you can use shielded STP cables to improve EMI problems.
6. The quality of UTP/STP cables can affect the transmission distance.
7. The video quality is subject to the resolution of the source, also the connected display should be compatible with the resolution of the source

Data Link TIA/EIA-568-B		
PIN	Color	Function
1	 W-O	TX0-
2	 O	TX0+
3	 W-G	TX1-
4	 BL	TX2-
5	 W-BL	TX2+
6	 G	TX1+
7	 W-BR	TXC-
8	 BR	TXC+

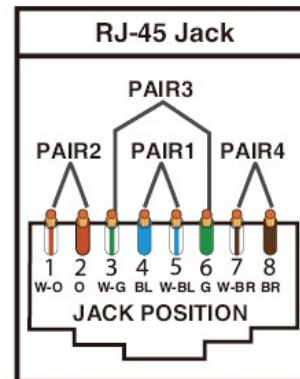

PERFORMANCE GUIDE FOR HDMI OVER CATEGORY CABLE TRANSMISSION

Performance Rating		Type Of Category Cable		
WIRING	SHIELDING	CAT5	CAT5E	CAT6
SOLID	UNSHIELDED (UTP)	★★★	★★★★	★★★★★
	SHIELDED (STP)	★★★	★★★★	★★★★★
STRANDED	UNSHIELDED (UTP)	★	★★	★★
	SHIELDED (STP)	★	★	★★
TERMINATION		PLEASE USE EIA/TIA-568-B TERMINATION (T568B) AT ANY TIME		





AV Connectivity, Distribution And Beyond...

TECHNICAL SUPPORT

CONTACT US



Phone: 1 (866) 508 0269



Email: support@avenview.com



USA Head Office Avenview Corp. 275 Woodward Avenue Kenmore, NY 14217

Disclaimer

While every precaution has been taken in the preparation of this document, Avenview Inc. assumes no liability with respect to the operation or use of Avenview hardware, software or other products and documentation described herein, for any act or omission of Avenview concerning such products or this documentation, for any interruption of service, loss or interruption of business, loss of anticipatory profits, or for punitive, incidental or consequential damages in connection with the furnishing, performance, or use of the Avenview hardware, software, or other products and documentation provided herein.

Avenview Inc. reserves the right to make changes without further notice to a product or system described herein to improve reliability, function or design. With respect to Avenview products which this document relates, Avenview disclaims all express or implied warranties regarding such products, including but not limited to, the implied warranties of merchantability, fitness for a particular purpose, and non-infringement.